

## Section 18 - Suspension Components

FPA No.	Description	Application	Alternate No.
 <b>0203169000</b>	Spring Eye Bush Steel/ Rubber/ Steel For Rubber Type Use 0203160600		IT3323A
 <b>0252207412</b>	Lock Nut M24 Grade 10.9	Suits All BPW M24 U Bolts	IT3339
 <b>0252733380</b>	Lock Nut M12	Suits all BPW Airbag Top Plates	IT3379
 <b>0311302060TS</b>	Air Suspension Boss Hanger Bush Comes With Lugs		
 <b>0326015010</b>	Lock Nut M30		IT3325 FL96.2809

## Section 18 - Suspension Components

FPA No.	Description	Application	Alternate No.
 <b>0332036080TS</b>	Wear Disc Inner And Outer		IT3323K
 <b>0334015270</b>	Bolt M30 x 190MM		IT3324 FL88.2412
 <b>09.1100.9</b>	Polyurethane Equaliser Bush O.D: 3-1/2" I.D: 2" Length: 4-3/8" 2 Piece Red Poly	York Macteco Sinclair Fruehauf FR + P2 Rubery Owen Late 'M' Freightler VE50 McGrath Late	
 <b>09.1101.9</b>	Polyurethane Equaliser Bush O.D: 3-1/2" I.D: 2" Length: 4-3/8" Red Poly	York Macteco Sinclair Fruehauf FR + P2 Rubery Owen Late 'M' Freightler VE50 McGrath Late	IT1101P SP1101-P WT1101U
 <b>09.1301.8</b>	Polyurethane Torque Rod Bush O.D: 2-3/16" I.D. Thread: 1-1/4" Length: 2-3/8" 3 Piece Snap Fit Including Washer Red Poly	York Macteco Sinclair Fruehauf FR + P2 Rubery Owen Late 'M' Freightler VE50 McGrath Late	

## Section 18 - Suspension Components

FPA No.	Description	Application	Alternate No.
 <b>09.1301.9</b>	Polyurethane Torque Rod Bush  O.D: 2-3/16" I.D. Thread: 1-1/4" Length: 2-3/8"  Red Poly	York Macteco Sinclair Fruehauf FR + P2 Rubery Owen Late 'M' Freighter VE50 McGrath Late	IT1301P SP1301-P WT1301U
 <b>FP1101</b>	Equaliser Bush  O.D: 3-1/2" I.D: 2" Length: 4-3/8"	York Macteco Sinclair Fruehauf FR + P2 Rubery Owen Late 'M' Freighter VE50 McGrath Late	09.1101.0 203-02442 FL80.2000 FP1101MULL IT1101 IT1101M (MULLINS) SP1101 WT1101
 <b>FP1101MULL</b>	Equaliser Bush  O.D: 3-1/2" I.D: 2" Length: 4-3/8"  <b>MULLINS</b>	York Macteco Sinclair Fruehauf FR + P2 Rubery Owen Late 'M' Freighter VE50 McGrath Late	09.1101.0 203-02442 FL80.2000 FP1101 IT1101 IT1101M (MULLINS) SP1101 WT1101
 <b>FP1101P</b>	Equaliser Bush  O.D: 3-1/2" I.D: 2" Length: 4-3/8"  Red Poly With Nylon Inner Sleeve	York Macteco Sinclair Fruehauf FR + P2 Rubery Owen Late 'M' Freighter VE50 McGrath Late	09.1101.0 203-02442 FL80.2000 FP1101MULL IT1101 IT1101M (MULLINS) SP1101 WT1101
 <b>FP1102</b>	Equaliser Bush 2 x 3/4" holes  O.D: 3-1/4" Length: 3-7/8"	Fruehauf S2 McGrath	09.1102.0 FL80.2001 IT1102 SP1102 WT1102





## Section 18 - Suspension Components

FPA No.	Description	Application	Alternate No.
 <b>FP1103</b>	Equaliser Bush 2 x 3/4" Holes O.D: 3-1/4" Length: 4-7/16"	Freighter TAA 39 and TAA 49	09.1107.0 161-07025 FL80.2002 IT1103 SP1108 WT1103
 <b>FP1104</b>	Equaliser Bush O.D: 3-1/8" I.D: 2" Length: 4-1/4"	Freighter TAA 29 and TAA 30 Dayton Blair York	09.1104.0 203-00021 FL80.2003 IT1104 SP1104 WT1104
 <b>FP1105</b>	Equaliser Bush Outer O.D: 3-5/8" I.D: 2-1/4" - 2-3/8" Length: 1-15/16"	Freighter TAA 35, 36, 37, 40	09.1105.0 203-01525 FL80.2004 IT1105 SP1105 WT1105
 <b>FP1106</b>	Equaliser Bush Inner O.D 3-3/8" I.D: 2" - 2-1/2" Length: 1-7/8"	Freighter TAA 35, 36, 37, 40	09.1106.0 203-01526 FL80.2005 IT1106 SP1120 WT1106
 <b>FP1109</b>	Equaliser Bush O.D: 3-1/8" I.D: 1-1/2" Length: 4-1/2"	Reyco 101, 101A, 102W Truck spec	08363-1 09.1109.0 FL80.2008 IT1109 SP1133 WT1109

## Section 18 - Suspension Components

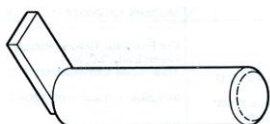
FPA No.	Description	Application	Alternate No.
 <b>FP1110</b> <b>FP1110P</b>	Equaliser Bush O.D: 3-3/8" I.D: 1-5/8" Length: 4-13/32"	Reyco 21B	09.1110.0 FL80.2009 IT1110 SP1130 T5524 WT1110
 <b>FP1112</b>	Equaliser Bush includes Sleeve O.D: 3-1/4" I.D: 1" Length: 3-7/8"	Reyco Transpro	0649-02 09.1112.0 IT1112 SP1134 WT1112
 <b>FP1199</b>	Equaliser Bush 'No Slots' O.D: 3-1/8" I.D: 1-1/2" Length: 4-1/2"	Reyco 101, 101A, 102W Truck spec.	14713-01 IT1199
 <b>FP1201</b>	Equaliser Bolt and Nut Assembly (Forged Bolt). 2" O.D 8-3/4" Length 1" UNF Thread	York Macteco Sinclair Fruehauf FR +P2 Rubery Owen Late 'M' Freighter VE50 McGrath Late	09.1201.0 FL81.2050 IT1201HD SP1201HD WT1201C
 <b>FP1202</b>	Equaliser Bolt 3/4" O.D 6" Length 5/8" UNF Thread	Fruehauf S2 McGrath Uses: 9411658 nut	09.1202.0 FL81.2051 IT1202 SP1204 WT1202

## Section 18 - Suspension Components

FPA No.	Description	Application	Alternate No.
 <b>FP1205S</b>	Equaliser Bolt 1-1/2" O.D 13-5/8" Length 1-1/2" UNF Thread	Freighter TAA 35, 36, 37, 40  Uses: FP1221 nuts FP1232 washers	09.1205.0 203-02414 FL80.2055 IT1205S SP1225 WT1205S
 <b>FP1207</b>	Equaliser Pin 2" O.D 6-7/8" Length	Freighter TAA 29	09.1207.0 203-00360 FL81.2056 SP1203 WT1207
 <b>FP1212</b>	Washer 4" O.D 1-1/16" I.D	Washer to suit FP1201 FP1216	IT1201W
 <b>FP1213-1</b>	Equaliser Shaft 1-1/2" O.D 8" Length 1-7/16" UNF Thread	Reyco 101, 101A, 102, 102W  Uses: FP1213A nut FP1213W washers	09.1213.0 FL80.2058 IT1213-1 SP1229/1 WT1213
 <b>FP1219</b>	1" UNF Nyloc Nut 12 TPI	Use with: FP1201HD FP1401HD FP1402 FP1216	151-15329 CH5505 FL96.2802 IT1219 WT1219

## Section 18 - Suspension Components

FPA No.	Description	Application	Alternate No.
 <b>FP1220</b>	1" UNF Nyloc Nut 14 TPI	Use with: FP1415	CH5511 IT1220
 <b>FP1221</b>	1-1/2" UNF Nyloc Nut	Use with: FP1205S	CH5502 IT1221 WT1221
 <b>FP1223</b>	Equaliser Bolt  3/4" O.D 6-1/2" Length 5/8" UNF Thread	Freighter TAA 49  Uses: 850932R91 Nut	161-07019 IT1223 SP1206 WT1223
 <b>FP1228</b>	Equaliser Shaft Assembly  1-5/8" O.D 8-11/16" Length 1" UNF Thread 14 TPI	Reyco 21B	FL80.2059 IT1228 SP1217 T69315 WT1216
 <b>FP1231</b>	Lock	Freighter TAA 49 Fruehauf S2 Use with: FP1202 FP1223	161-07017 IT1231 WT1231

## Section 18 - Suspension Components

FPA No.	Description	Application	Alternate No.
 <b>FP1232</b>	Cast Washer	Freighter TAA 35, 36, 37, 40  Use with: FP1205S	237-00436 IT1232 WT1232
 <b>FP1233</b>	Equaliser Casting	Freighter TAA 35, 36, 37, 40  Use with: FP1205S	237-00433 FL80.2013 SP1121 WT1233
 <b>FP1301</b>	Torque Rod Bush  O.D: 2-3/16" I.D. Thread: 1-1/4" Length: 2-3/8"	York Macteco Sinclair Fruehauf P + F Freighter TAA49 + VE50 McGrath Rubery Owen	09.1301.0 161-07043 FL83.2151 FP1301MULL IT1301 SP1301 WT1301S
 <b>FP1301MULL</b>	Torque Rod Bush  O.D: 2-3/16" I.D. Thread: 1-1/4" Length: 2-3/8"  <b>MULLINS</b>	York Macteco Sinclair Fruehauf P + F Freighter TAA49 + VE50 McGrath Rubery Owen	09.1301.0 161-07043 FL83.2151 FP1301 IT1301 SP1301 WT1301S
 <b>FP1301P</b>	Torque Rod Bush  O.D: 2-3/16" I.D. Thread: 1-1/4" Length: 2-3/8"  Red Poly With Nylon Inner Sleeve	York Macteco Sinclair Fruehauf P + F Freighter TAA49 + VE50 McGrath Rubery Owen	09.1301.0 161-07043 FL83.2151 FP1301MULL IT1301 SP1301 WT1301S



## Section 18 - Suspension Components

FPA No.	Description	Application	Alternate No.
 <b>FP1302</b>	Torque Rod Bush O.D: 1-15/16" I.D. Thread: 1" Length: 3"	Fruehauf S2 Freightler TAA39 McGrath	161-07020 09.1302.0 FL83.2152 IT1302 SP1302 WT1302
 <b>FP1303</b>	Torque Rod Bush O.D: 2-3/8" I.D. Thread: 1-5/16" Length: 2-1/4"	Freightler TAA26, 29	203-00052 FL83.2153 IT1303 SP1303 WT1303
 <b>FP1304</b>	Torque Rod Bush Inner O.D: 2-3/8" I.D. Thread: 1-7/16" Length: 2-1/4"	Freightler TAA35, 36, 37, 40	09.1304.0 203-01314 FL83.2154 IT1304 WT1304
 <b>FP1305</b>	Torque Rod Bush Outer O.D: 3-1/16" I.D. Thread: 1-13/16" Length: 15/16"	Freightler TAA35, 36, 37, 40	09.1305.0 203-01315 IT1305 SP1305 WT1305
 <b>FP1306</b>	Torque Rod Bush One Piece O.D: 3-1/8" to 2-1/8" I.D. Thread: 1-1/4" Length: 3"	Freightler TAA35, 36, 37, 40  Alternative to: FP1304 FP1305 FP1417	FL83.2156 IT1306 SP1313 WT1306

## Section 18 - Suspension Components

FPA No.	Description	Application	Alternate No.
 <b>ZWT1306WL</b>	Washer O.D: 3-1/8" I.D. Thread: 1-1/4" Length: 3/16"	Freightler TAA35, 36, 37, 40 Use with: FP1306	IT1306WL SP1456 WT1306WL
 <b>ZWT1306WS</b>	Washer O.D: 2-1/8" I.D. Thread: 1-1/32" Length: 3/16"	Freightler TAA35, 36, 37, 40 Use with: FP1306	IT1306WS SP1455 WT1306WS
 <b>FP1308</b>	Torque Rod Bush O.D: 1-29/32" I.D. Thread: 7/8" Length: 3" For Heavy Duty Version Use FP1328	Rubery Owen Blair Colrain Dayton Reyco 101A + 102W Reyco Transpro Sinclair	09.1308.0 FL83.2158 IT1308 SP1308 WT1308 Reyco 09729-01
 <b>FP1309</b>	Torque Rod Bush Axle End O.D: 2-3/8" to 1-3/4" I.D. Thread: 1" Length: 2-11/16"	Rubery Owen 'R' series Reyco 102	FL83.2159 IT1309 SP1309 WT1309 Reyco T-2242
 <b>FP1310</b>	Torque Rod Bush Hanger End O.D: 3-1/16" to 1-13/16" I.D. Thread: 1" Length: 2-11/16"	Reyco 102 + 102W	09.1310.0 FL83.2160 IT1310N SP1314 WT1310 Reyco T-1842 G.T.S 21238-01

## Section 18 - Suspension Components

FPA No.	Description	Application	Alternate No.
 <b>FP1311</b>	Torque Rod Bush O.D: 2-3/8" to 1-13/16" I.D. Thread: 1" Length: 3"	Reyco 21B Trailer Susp.	FL83.2161 IT1311 SP1315 T5493 WT1311
 <b>FP1328</b>	Torque Rod Bush "Tapered HD Version" of FP1308 O.D: 1-29/32" I.D. Thread: 7/8" Length: 3"	Can Be Used As Substitute For FP1308	09.1328.0 BP1312 FP1328MULL IT1328 WT1312
 <b>FP1328MULL</b>	Torque Rod Bush "Tapered HD Version" of FP1308 O.D: 1-29/32" I.D. Thread: 7/8" Length: 3"  <b>MULLINS</b>	Can Be Used As Substitute For FP1308	09.1328.0 BP1312 FP1328 IT1328 WT1312
 <b>FP1401</b>	Torque Rod Bolt and Nut Assembly (Forged Bolt). O.D: 1-1/4" Length: 6" 1" UNF Thread	Macteco Sinclair Fruehauf P + F Freighter McGrath Haulmark	09.1401.0 FL83.2400 IT1401HD SP1401HD WT1401C
 <b>FP1402</b>	Torque Rod Bolt O.D: 1" Length: 5" 1" UNF Thread	Freighter TAA39	09.1402.0 (1"x6") CH0501 IT1402 WT1402

## Section 18 - Suspension Components

FPA No.	Description	Application	Alternate No.
 <b>ZWT1402L</b>	Torque Rod Bolt and Nut O.D: 1" Length: 6" 1" UNF Thread	Freighter S2 Uses: FP1219 nut	09.1402.2 (1"x7") CH0513 IT1402L
 <b>FP1403</b>	Torque Rod Bolt O.D: 7/8" Length: 6-1/4" 7/8" UNC Thread	Colrain Haulmark (ETE)	09.1403.0 IT1403
 <b>FP1403L</b>	Torque Rod Bolt "Long version" O.D: 7/8" Length: 7-1/4" 7/8" UNC Thread	Reyco Haulmark (ETE)	09.1403.4 CH0504 IT1403L
 <b>FP1403N</b>	Conelock Nut 7/8" UNC Thread	Suits: FP1403 FP1403L FP1403S	CH5506 IT1403N
 <b>FP1404</b>	Torque Rod Bolt and Nut O.D: 1-5/16" Length: 6-1/4" 7/8" UNF Thread	Freighter TAA21, 26, 29	IT1404 SP1404 WT1404





## Section 18 - Suspension Components

FPA No.	Description	Application	Alternate No.
 <b>FP1405</b>	Torque Rod Bolt and Nut O.D: 1-1/4" Length: 6-1/8" 1" UNF Thread	Freighter TAA 35, 36, 37, 40	09.1405.0 IT1405 SP1405 WT1405
 <b>FP1415</b>	Torque Rod Bolt O.D: 1" Length: 7-1/4" 1" UNF Thread	Reyco 21B, 102, 102W Use: FP1220 Nut	IT1415 WT1415
 <b>ZWT1403S</b>	Torque Rod Bolt "Standard version" O.D: 7/8" Length: 5-3/4" 7/8" UNC Thread	Reyco 102W Rubery Owen Blair Dayton Sinclair Haulmark (ETE) Uses: FP1403N nut	09.1403.0 10033-01 IT1403S WT1403
 <b>ZWT1413</b>	Torque Rod Bolt O.D: 1" Length: 6-3/8" 1" UNC Thread	Reyco 102 Use 3248463R1 1" locknut	IT1413 WT1413
 <b>FP1408</b>	Washer O.D: 2-3/4" I.D: 1-1/16"	Washer to suit FP1401	IT1401W



## Section 18 - Suspension Components

FPA No.	Description	Application	Alternate No.
 <b>FP1414</b>	Washer O.D: 2-3/4" I.D: 1-1/16"	Reyco 21B + 102W Suits: FP1413	IT1414 T-2224 WT1414 FL94.2708
 <b>FP1450</b>	Repair Boss Bush O.D: 1-3/4" I.D: 7/8" Depth: 7/16"	Repair Boss For Torque Rod Bolt Hole On Common Parallel Type Hangers	09.0331.0
 <b>ZWT1403W</b>	Washer O.D: 1-7/8" I.D: 15/16"	Suits: FP1403 FP1403L FP1403S	IT1403W
 <b>ZWT1411</b>	Washer O.D: 3-11/16" I.D: 1-1/8"	Reyco 102, 102W Suits: FP1415	IT1411 T-1724 WT1411
 <b>FP24948</b>	Torque Rod Casting O.D: 2-3/4" - 1-1/2" I.D: 1-1/4" Length: 2-1/8"	Freighter TAA35, 36, 37, 40	237-00434 BP1417 FL83.2164 IT1417 SP1306 T03-1306 WT1417

## Section 18 - Suspension Components

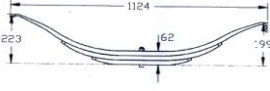
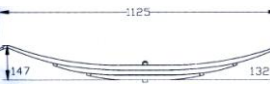

FPA No.	Description	Application	Alternate No.
 <p data-bbox="153 555 236 577"><b>FP008</b></p>	<p data-bbox="464 226 667 248">Spring Assembly</p> <p data-bbox="464 293 544 315">8 Leaf</p>	<p data-bbox="767 226 975 315">General Purpose Rubery Owen Sinclair Macteco</p>	<p data-bbox="1102 226 1182 248">IT008</p>
 <p data-bbox="153 913 256 936"><b>FP008A</b></p>	<p data-bbox="464 584 667 607">Spring Assembly</p> <p data-bbox="464 651 703 674">8 Leaf Double Hook</p>	<p data-bbox="767 584 975 674">General Purpose Rubery Owen Sinclair Macteco</p>	<p data-bbox="1102 584 1198 607">IT008A</p>
 <p data-bbox="153 1272 236 1294"><b>FP009</b></p>	<p data-bbox="464 943 667 965">Spring Assembly</p> <p data-bbox="464 1010 544 1032">9 Leaf</p>	<p data-bbox="767 943 975 1032">General Purpose Rubery Owen Sinclair Macteco</p>	<p data-bbox="1102 943 1182 965">IT009</p>
 <p data-bbox="153 1630 256 1653"><b>FP009A</b></p>	<p data-bbox="464 1301 667 1323">Spring Assembly</p> <p data-bbox="464 1368 703 1391">9 Leaf Double Hook</p>	<p data-bbox="767 1301 975 1391">General Purpose Rubery Owen Sinclair Macteco</p>	<p data-bbox="1102 1301 1198 1323">IT009A</p>
 <p data-bbox="153 1995 236 2018"><b>FP010</b></p>	<p data-bbox="464 1659 667 1682">Spring Assembly</p> <p data-bbox="464 1727 544 1749">10 Leaf</p>	<p data-bbox="767 1659 879 1682">Haulmark</p>	<p data-bbox="1102 1659 1246 1727">IT010 ZCSTS010</p>

## Section 18 - Suspension Components



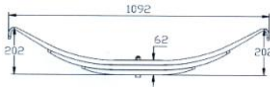
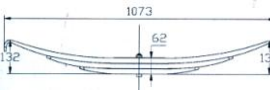
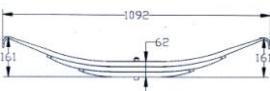

FPA No.	Description	Application	Alternate No.
 <b>FP013</b>	Spring Assembly 13 Leaf	Fruehauf	IT013
 <b>FP453</b>	Spring Assembly 9 Leaf Rating: 4990kg Weight: 43kg	Freighter	203-01453 T03-7438 ZCSTS453
 <b>FP564</b>	Spring Assembly 8 Leaf Med Arch Rating: 4990kg Weight: 43kg O.A.L. 42-1/4"	Reyco 21B Trailer	IT564 T-3564
 <b>FP0079-01</b>	Spring Assembly 3 Leaf End Spring High Arch Rating: 4990kg Weight: 24kg O.A.L. 44-5/16"	Reyco Transpro	IT7901
 <b>FP0079-02</b>	Spring Assembly 3 Leaf End Spring Low Arch Single Hook Rating: 4990kg Weight: 24kg O.A.L. 44-5/16"	Reyco Transpro	IT7902







## Section 18 - Suspension Components

FPA No.	Description	Application	Alternate No.
 <b>FP0329-00</b>	Spring Assembly 3 Leaf Centre High Arch Double Hook Rating: 4990kg Weight: 24kg O.A.L. 43-1/2"	Reyco Transpro	IT329
 <b>FP0335-00</b>	Spring Assembly 3 Leaf Centre Low Arch Double Hook Rating: 4990kg Weight: 24kg O.A.L. 13-1/2"	Reyco Transpro Tri-Axle	IT335
 <b>FP0694-00</b>	Spring Assembly 3 Leaf Centre Spring Med Arch Double Hook Rating: 4990kg Weight: 24kg O.A.L. 42-1/2"	Reyco Transpro Tri Axle	
 <b>FP08376-01</b>	Spring Assembly 3 Leaf Med Arch Single Hook Rating: 4545kg Weight: 24kg O.A.L. 42"	Reyco 21B Trailer	
 <b>FP09884-01</b>	Spring Assembly 15 Leaf Rating: 4500kg Weight: 56.5kg O.A.L. 44-3/4"	Reyco 102W Truck	ZCSREY-01





## Section 18 - Suspension Components

FPA No.	Description	Application	Alternate No.
 <b>FP7448</b>	Centre Bolt 1/2" x 8" Supplied With Nut	GP Centre Bolt Long Thread For Multi Fit Applications	AS7448 FL89.2491 ZCS5033
 <b>FP7449</b>	Centre Bolt 1/2" x 12" Supplied With Nut	GP Centre Bolt Long Thread For Multi Fit Applications	58694R1 AS7449 ZCS5036
 <b>FP7450</b>	Centre Bolt 7/16" x 12" Supplied With Nut	GP Centre Bolt Long Thread For Multi Fit Applications	1089521R91 AS7450 ZCS5028
 <b>FP7451</b>	Centre Bolt 3/8" x 8" Supplied With Nut	GP Centre Bolt Long Thread For Multi Fit Applications	AS7451 FL89.2492 ZCS5017
 <b>FP7452</b>	Centre Bolt 7/16" x 8" Supplied With Nut	GP Centre Bolt Long Thread For Multi Fit Applications	AS7452 FL89.2493 ZCS5025





## Section 18 - Suspension Components

FPA No.	Description	Application	Alternate No.
 <b>FP1150F</b>	Equaliser Cast 8'1" Tri Axles Width 120mm Length 416mm	Freighter VA49 Freighter VE50	09.1054.0 237-00446 FQ1156 FR24957 IT1150F SP1150
 <b>FP1151F</b>	Equaliser Fabricated 4' Tandem 8'1" Tri Axles Width 117mm Length 416mm Includes FP1104 Bush	Freighter TAA29	09.1051.1 IT1151F SP1151 WT1099
 <b>FP1152F</b>	Equaliser Fabricated 4' Tandem 8'1" Tri Axles Width 112mm Length 416mm Includes FP1103 Bush	Freighter TAA39 Freighter TAA49	09.1052.1 161-07052 237-07052 IT1152F SP1152
 <b>FP1153F</b>	Cast Equaliser 9' 0" Tri Axles Width 120mm Length 590mm	Freighter TAA35 Freighter TAA40 Freighter VA35	09.1061.0 237-00427 24944 SP1153
 <b>FP1154F</b>	Fabricated Equaliser 10' 1" Tri Axles Width 120mm Length 760mm	Freighter TAA35	09.1063.0 203-01873 FL82.2102 IT1154F SP1154 FQ1174

## Section 18 - Suspension Components

FPA No.	Description	Application	Alternate No.
 <b>FP1160F</b>	Cast Equaliser 9' 1" Tri Axles Width 120mm Length 585mm	Freighter VE50	237-00437 FQ1166 FR24950 IT1160F
 <b>FP1165</b>	Cast Equaliser 4' Tandems 8' Tri Axles Width 100mm Length 450mm	Fruehauf F2	09.1001.0 IT1165 SP1165 ULA21380 WT1005
 <b>FP1166</b>	Cast Equaliser 5' Tandems 10' Tri Axles Width 95mm Length 750mm	Fruehauf F2	09.1003.0 IT1166 SP1166 ULA21382 WT1007
 <b>FP1170F</b>	Fabricated Equaliser 4' Tandems 8' Tri Axles Includes FP1102 Bush Width 95mm Length 457mm	McGrath	09.1101.0 IT1170F MGR101 SP1170
 <b>FP1171F</b>	Fabricated equalised 5' Tandems 10' Tri Axles Includes FP1102 Bush Width 95mm Length 760mm	McGrath	09.1013.0 IT1171F MGR103 SP1171

## Section 18 - Suspension Components

FPA No.	Description	Application	Alternate No.
 <b>FP1175</b>	Cast Equaliser 10' 1" Tri Axles Width 130mm Length 780mm	Freighter VE50 Takes 1101 Bush	237-00453 FQ1175 FR24965
 <b>FP1182</b>	Cast Equaliser 4' Tandems 8' 1" Tri Axles Width 110mm Length 395	Macteco Sinclair Colrain Haulmark McGrath (Late) Rubery Owen	09.1042.0 289/3 FL82.2114 IT1182 SF0007 SP1182 YK59900007
 <b>FP1182M</b>	Cast Equaliser Multi Drilled 2 Holes 4' Tandems 8' 1" Tri Axles Width 110mm Length 395	Macteco Sinclair Colrain Haulmark McGrath (Late) Rubery Owen	
 <b>FP1183</b>	Cast Equaliser 5' Tandems 10' 1" Tri Axles Width 110mm Length 750mm	Macteco Sinclair Colrain Haulmark McGrath (Late) Rubery Owen	09.1047.0 FL82.2115 IT1183 SF0010 SP1183 YK59900010
 <b>FP1190</b>	Cast Equaliser 9' 1" Tri Axles Width 108mm Length 600mm	Macteco Sinclair Colrain Haulmark McGrath (Late) Rubery Owen	09.1045.0 IT1190 SF0020 SP1190 YK59900020

## Section 18 - Suspension Components

FPA No.	Description	Application	Alternate No.
 <b>FP1194</b>	Cast Equaliser suits Truck spec.  Includes FP1109 slotted bush  Width 105mm Length 400mm	Reyco 102W	09.1031.0 09120.01 IT1194 SP1194
 <b>FP1195 (Fabricated)</b> <b>FP1195C (Cast)</b>	Fabricated Equaliser  Includes FP1112 bush  Width 95mm Length 419mm	Transpro	0650-00 (Fabricated) 0850-00 (Cast) IT1195 SP1195
 <b>FP1196</b>	Cast Equaliser  8' 1" Tri Axles  Width 105mm Length 455mm	Reyco 21B	09.1092.0 IT1196 SP1196 T5427 WT1002
 <b>FP1197</b>	Cast Equaliser  9' 1" Tri Axles  Width 97mm Length 610mm	Freuhauf F2	IT1197 SP1197 ULA21381 WT1006
 <b>FP1198</b>	Cast Equaliser suits Truck spec.  Includes FP1199 Bush (No Slots)	Reyco 102W	14723-01 14743-01 IT1198

## Section 18 - Suspension Components

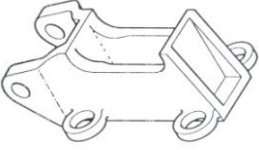
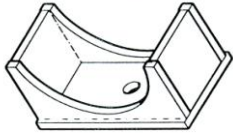
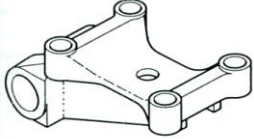
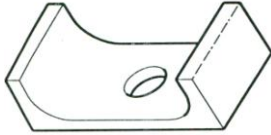
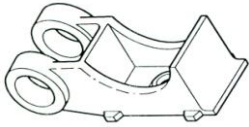
FPA No.	Description	Application	Alternate No.
 <p data-bbox="153 555 277 584"><b>09.0407.0</b></p>	<p data-bbox="459 230 644 353">Spring Seat 5" Square Axle 3" High Parallel Bush</p>	<p data-bbox="767 230 959 353">York  NLA From York</p>	<p data-bbox="1106 230 1209 286">8416BS 90068</p>
 <p data-bbox="153 916 277 945"><b>09.0416.0</b></p>	<p data-bbox="459 591 638 680">Spring Seat 5" Round Axle</p>	<p data-bbox="767 591 1002 680">Freighter VE50  Suits 3 1/2" Springs</p>	<p data-bbox="1106 591 1241 620">237-00407</p> <p data-bbox="1106 687 1414 743">Use 5 Hole Plate 09.0417.0 With This Item</p>
 <p data-bbox="153 1276 277 1305"><b>09.0420.0</b></p>	<p data-bbox="459 952 580 981">Axle Seat</p>	<p data-bbox="767 952 922 981">Fruehauf F2</p>	<p data-bbox="1106 952 1257 981">AXA-0495-1</p>
 <p data-bbox="153 1637 277 1666"><b>09.0422.0</b></p>	<p data-bbox="459 1312 608 1341">Spring Seat</p>	<p data-bbox="767 1312 922 1341">Fruehauf F2</p>	<p data-bbox="1106 1312 1246 1341">AXA-05121</p>
 <p data-bbox="153 1995 277 2024"><b>09.0423.0</b></p>	<p data-bbox="459 1673 638 1762">Axle Seat 5" Round Axle</p>	<p data-bbox="767 1673 954 1702">Freighter VE50</p>	<p data-bbox="1106 1673 1241 1702">237-00447</p>

## Section 18 - Suspension Components





FPA No.	Description	Application	Alternate No.
 <b>09.0501.6</b>	Spring Top Plate	GP Overslung Suspension Use for Haulmark  Suits 3" Wide Spring Assy 5" Round or Square Axles	CS277 FL90.2541 IT6815
 <b>CS292</b>	Spring Seat  5" Round Axle 75mm High Parallel Bush	Haulmark	09.0400.6 FL90.2502 WT1715
 <b>CS578</b>	Spring Seat  5" Round Axle 3/4" High Tapered Bush	Haulmark	
 <b>FP2839</b>	Spring Top Plate	Fruehauf F2	09.0515.0
 <b>FP6816A</b>	Spring Seat  127mm Round Axle 25mm High Parallel Bush	Sinclair Haulmark	09.0401.6 CS278 FL90.2503 IT6816A WT1714







## Section 18 - Suspension Components

FPA No.	Description	Application	Alternate No.
 <b>YK59900003</b>	Spring Top Plate	GP Overslung Suspension  Suits 3" Wide Spring Assy 5" Round or Square Axles	09.0501.0 FL90.2540
 <b>YK59900008</b>	Spring Seat 6" Square Axle 1" High Tapered Bush	York	90008
 <b>YK59900025</b>	Spring Seat  127mm Round Axle 75mm High Tapered Bush	York	09.0410.0 8216B 90025 CS592 FL90.2500 WT1711
 <b>YK59900027</b>	Spring Seat  127mm Round Axle 25mm High Tapered Bush	York Macteco Sinclair Haulmark ETE	90027 09.0411.0 8216A CS276A FL90.2501 IT8216A KH690027 WT1710
 <b>YK59900049</b>	Spring Seat  127mm Square Axle 25mm High Tapered Bush	York	8416AT 90049 FL90.2505 WT1716

## Section 18 - Suspension Components

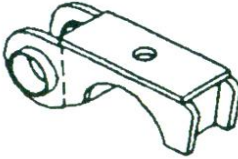
FPA No.	Description	Application	Alternate No.
 <b>YK59900071</b>	Spring Seat  5" Square Axle 75mm High Tapered Bush	York	8416BT 90071 FL90.2504
 <b>ZTE0538-00 See Notes</b>	Bottom Plate  5" Round Axle Underslung 5" Square Axle	Reyco 88 and 89 Transpro  ZTE0538-00 ZTE0858-00 ZTE0149-00	
 <b>ZTE0636-01 See Notes</b>	Spring Seat  5" Round Axle 1" High 5" Round Axle 2" High 5" Square Axle 5" Underslung Axle	88 Reyco Transpro  ZTE0636-01 ZTE0636-02 ZTE0632-01 ZTE0637-01	IT4814 IT4815
 <b>ZTE09139-01</b>	Bottom Plate  5" Round Axle	Reyco 21B	IT2875
 <b>ZTE09730-01 See Notes</b>	Spring Seat  5" Round Axle 3/4" High 5" Round Axle 2" High 5" Round Axle 3" High	21B Reyco  ZTE09730-01 ZTE19982-01 ZTE08757-01	





## Section 18 - Suspension Components

FPA No.	Description	Application	Alternate No.
 <b>ZTE1416-01 See Notes</b>	Spring Seat  5" Round Axle 1" High 5" Square Axle 5" Underslung Axle	89 Reyco  ZTE1416-01 ZTE1415-01 ZTE0637-01	
 <b>203-02522</b>	Torque Rod End LH 1-3/8" Threaded Bore  Supplied Without Clamp Bolts	VE 50 Freighter  Suits FP1301 Bush	T03-1415
 <b>203-02523</b>	Torque Rod End RH 1-3/8" Threaded Bore  Supplied Without Clamp Bolts	VE 50 Freighter  Suits FP1301 Bush	T03-1416
 <b>FP0004L</b>	Torque Rod End LH 1-1/2" Threaded Bore  Supplied Without Clamp Bolts	GP Rod End Suits Parallel Bushed 1-1/2" Rods  Suits FP1328 Bush	09.3102.L IT6807
 <b>FP0004R</b>	Torque Rod End RH 1-1/2" Threaded Bore  Supplied Without Clamp Bolts	GP Rod End Suits Parallel Bush 1-1/2" Rods  Suits FP1328 Bush	09.3102.R IT6808





## Section 18 - Suspension Components

FPA No.	Description	Application	Alternate No.
 <b>FP0024L</b>	Torque Rod End LH 1-1/2" Threaded Bore  Supplied Without Clamp Bolts	GP Rod End Suits Tapered Bush 1-1/2" Rods  Suits FP1301 Bush	09.3202.L YK59SB900024L
 <b>FP0024R</b>	Torque Rod End RH 1-1/2" Threaded Bore  Supplied Without Clamp Bolts	GP Rod End Suits Tapered Bush 1-1/2" Rods  Suits FP1301 Bush	09.3202.R YK59SB900024R
 <b>YK59SB900024L</b>	HD Torque Rod End LH 1-1/2" Threaded Bore  Supplied With Clamp Bolts	GP Rod End Suits Tapered Bush 1-1/2" Rods  Suits FP1301 Bush	09.3202.L FP0024L
 <b>YK59SB900024R</b>	HD Torque Rod End LH 1-1/2" Threaded Bore  Supplied With Clamp Bolts	GP Rod End Suits Tapered Bush 1-1/2" Rods  Suits FP1301 Bush	09.3202.R FP0024R
 <b>ZTE20141-01</b>	Torque Rod End LH 1-1/2" Threaded Bore	Reyco 21B  Suits FP1311 Bush	





## Section 18 - Suspension Components

FPA No.	Description	Application	Alternate No.
 <b>ZTE20141-02</b>	Torque Rod End RH 1-1/2" Threaded Bore	Reyco 21B  Suits FP1311 Bush	
 <b>203-02528</b>	Torque Arm Screw 305mm X 1-3/8"	VE 50 Freighter	T03-1346
 <b>203-02530</b>	Torque Arm Screw 375mm X 1-3/8"	VE 50 Freighter	T03-1347
 <b>203-02545</b>	Torque Arm Screw 470mm X 1-3/8"	VE 50 Freighter	T03-1348
 <b>YK59900033/01</b>	Torque Arm Screw 260mm X 1-1/2"	All Spreads	FP0034 IT6406

## Section 18 - Suspension Components

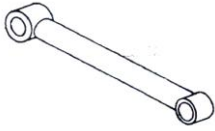
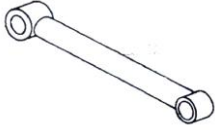
FPA No.	Description	Application	Alternate No.
 <b>YK59900033/02</b>	Torque Arm Screw 350mm X 1-1/2"	8'1" & 10'1" Spread	FP0033 IT6428
 <b>YK59900033/03</b>	Torque Arm Screw 420mm X 1-1/2"		IT6529
 <b>YK59900033/04</b>	Torque Arm Screw 480mm X 1-1/2"		
 <b>ZTE0029-23</b>	Torque Arm Screw 14-3/4"	Reyco 21B	
 <b>YK59901100/VARIOUS</b>	Torque Rod Fixed With Tapered Bush Seats YK59901100/360 YK59901100/380 YK59901100/395 YK59901100/450 YK59901100/470 YK59901100/495 YK59901100/530 YK59901100/565 YK59901100/620	GP Fixed Rod	

## Section 18 - Suspension Components





FPA No.	Description	Application	Alternate No.
 <p><b>ZTE09686-01</b></p>	Torque Rod Fixed 635mm	Reyco 21B	
 <p><b>ZTE10183-01</b></p>	Torque Rod Fixed 548mm	Reyco 21B	
 <p><b>ZTE15017-01</b></p>	Torque Arm Screw 11-3/4"	Reyco 21B	
 <p><b>ZTE15019-01</b></p>	Torque Arm Screw 18-1/2"	Reyco 21B	
 <p><b>ZTE15020-01</b></p>	Torque Arm Screw 20"	Reyco 21B	

## Section 18 - Suspension Components

FPA No.	Description	Application	Alternate No.
 <b>ZTET2293</b>	Torque Rod Fixed 479mm	Reyco 21B	
 <b>FP3001</b>	U Bolt Deep Nut 3/4"	Common 3/4" Deep Nut 14 TPI Suits Various Applications	FL91.2597
 <b>FP3002A</b>	U Bolt Deep Nut 7/8"	Common 7/8" Deep Nut 14 TPI Suits Various Applications	FL91.2599
 <b>0254012507</b>	U Bolt Washer Hardened 25mm X 44mm X 4mm	SL Only	
 <b>FP2545</b>	U Bolt Washer 3/4" Hardened	Common 3/4" U Bolt Washer Suits Various Applications	FL91.2596 ZCS5208







## Section 18 - Suspension Components

FPA No.	Description	Application	Alternate No.
 <b>FP2546</b>	U Bolt Washer 7/8" Hardened	Common 7/8" U Bolt Washer Suits Various Applications	FL91.2598 ZCS5209
 <b>0313835100</b>	U Bolt M20 X 165 X 365	BPW GW18	
 <b>0313841080</b>	U Bolt M24 X 152 X 320  Lock Nut 0252207412	BPW OT D36	IT3370
 <b>0313841130</b>	U Bolt M24 X 152 X 300  Lock Nut 0252207412	BPW OT D30	
 <b>0313841160</b>	U Bolt M24 X 152 X 310  Lock Nut 0252207412	BPW OM	IT3330



## Section 18 - Suspension Components

FPA No.	Description	Application	Alternate No.
 <b>0313841170</b>	U Bolt M24 X 152 X 290 Now use 0313841174  Lock Nut 0252207412 Washer 0254012507	BPW SLU D30K	0313841174
 <b>0313841174</b>	U Bolt M24 X 152 X 290  Lock Nut 0252207412 Washer 0254012507	BPW SLU D30K	
 <b>0313841330</b>	U Bolt FLAT TYPE M24 X 152 X 283  Lock Nut 0252207412	Jurss BPW Disc Brake Axle  Use Castellated Nut 0252733488	
 <b>0313844013</b>	U Bolt M24 X 125 X 356  Lock Nut 0252207412	BPW OM D36 H/D 150 Square	
 <b>0313844023</b>	U Bolt M24 X 125 X 331  Lock Nut 0252207412	BPW	



## Section 18 - Suspension Components

FPA No.	Description	Application	Alternate No.
 <b>0313844041</b>	U Bolt M24 X 125 X 301  Lock Nut 0252207412	BPW OT D36  U Bolts Up	
 <b>0313844084</b>	U Bolt M24 X 125 X 280  Lock Nut 0252207412 Washer 0254012507	BPW SLM SLO	IT3329
 <b>0313844120</b>	U Bolt M24 X 125 X 370  Lock Nut 0252207412	BPW	
 <b>0313844153</b>	U Bolt M24 X 125 X 320  Lock Nut 0252207412	BPW	
 <b>0313845060</b>	U Bolt M24 X 180 X 370  Lock Nut 0252207412	BPW OT 150 Square Freeport	

## Section 18 - Suspension Components

FPA No.	Description	Application	Alternate No.
 <b>0313845070</b>	U Bolt M24 X 180 X 360  Lock Nut 0252207412	BPW OT 150 Square Corradini	
 <b>0313845120</b>	U Bolt M24 X 125 X 370  Lock Nut 0252207412	BPW OT 150 Square Freeport	
 <b>FP2366A</b>	GP 7/8" U Bolt 3" X 13.5" X 7/8"  With Nuts And Washers  Nut FP3002A Washer FP2546	Multi-fit Type 150mm Thread Length to Suit Many Applications	
 <b>FP2367A</b>	GP 7/8" U Bolt 3" X 17.5" X 7/8"  With Nuts And Washers  Nut FP3002A Washer FP2546	Multi-fit Type 150mm Thread Length to Suit Many Applications	
 <b>FP2368A</b>	GP 7/8" U Bolt 5" X 14.5" X 7/8"  With Nuts And Washers  Nut FP3002A Washer FP2546	Multi-fit Type 150mm Thread Length to Suit Many Applications	





## Section 18 - Suspension Components

FPA No.	Description	Application	Alternate No.
 <b>FP2369A</b>	GP 7/8" U Bolt 5" X 17.5" X 7/8"  With Nuts And Washers  Nut FP3002A Washer FP2546	Multi-fit Type 150mm Thread Length to Suit Many Applications	
 <b>YK59901101/240</b>	U Bolt 127mm Round Axle 240mm Long With Nuts And Washers  Nut FP3002A Washer FP2546	York	
 <b>YK59901101/275</b>	U Bolt 127mm Round Axle 275mm Long With Nuts And Washers  Nut FP3002A Washer FP2546	York	
 <b>YK59901101/290</b>	U Bolt 127mm Round Axle 290mm Long With Nuts And Washers  Nut FP3002A Washer FP2546	York	
 <b>YK59901101/315</b>	U Bolt 127mm Round Axle 315mm Long With Nuts And Washers  Nut FP3002A Washer FP2546	York	

## Section 18 - Suspension Components

FPA No.	Description	Application	Alternate No.
 <b>YK59901101/325</b>	U Bolt 127mm Round Axle 325mm Long With Nuts And Washers  Nut FP3002A Washer FP2546	York	FP2369A
 <b>YK59901101/350</b>	U Bolt 127mm Round Axle 350mm Long With Nuts And Washers  Nut FP3002A Washer FP2546	York	FP2368A
 <b>YK59901101/370</b>	U Bolt 127mm Round Axle 370mm Long With Nuts And Washers  Nut FP3002A Washer FP2546	York	FP2368A
 <b>YK59901102/310</b>	U Bolt 122mm Square Axle 310mm Long With Nuts And Washers  Nut FP3002A Washer FP2546	York	
 <b>YK59901102/345</b>	U Bolt 122mm Square Axle 345mm Long With Nuts And Washers  Nut FP3002A Washer FP2546	York	

## Section 18 - Suspension Components



FPA No.	Description	Application	Alternate No.
 <p data-bbox="153 555 368 584"><b>YK59901102/370</b></p>	<p data-bbox="459 226 767 421">U Bolt 122mm Square Axle 370mm Long With Nuts And Washers</p> <p data-bbox="459 427 767 488">Nut FP3002A Washer FP2546</p>	<p data-bbox="767 226 1106 255">York</p>	
 <p data-bbox="153 913 368 943"><b>YK59901102/410</b></p>	<p data-bbox="459 584 767 779">U Bolt 122mm Square Axle 410mm Long With Nuts And Washers</p> <p data-bbox="459 786 767 846">Nut FP3002A Washer FP2546</p>	<p data-bbox="767 584 1106 613">York</p>	
 <p data-bbox="153 1272 368 1301"><b>YK59901103/360</b></p>	<p data-bbox="459 943 767 1137">U Bolt 152mm Square Axle 360mm Long With Nuts And Washers</p> <p data-bbox="459 1144 767 1205">Nut FP3002A Washer FP2546</p>	<p data-bbox="767 943 1106 972">York</p>	
 <p data-bbox="153 1630 368 1659"><b>YK59901102/380</b></p>	<p data-bbox="459 1301 767 1496">U Bolt 152mm Square Axle 380mm Long With Nuts And Washers</p> <p data-bbox="459 1503 767 1563">Nut FP3002A Washer FP2546</p>	<p data-bbox="767 1301 1106 1330">York</p>	
 <p data-bbox="153 1995 368 2024"><b>YK59901102/410</b></p>	<p data-bbox="459 1659 767 1854">U Bolt 152mm Square Axle 410mm Long With Nuts And Washers</p> <p data-bbox="459 1861 767 1921">Nut FP3002A Washer FP2546</p>	<p data-bbox="767 1659 1106 1688">York</p>	

## Section 18 - Suspension Components



FPA No.	Description	Application	Alternate No.
 <b>YK61SB506245/270</b>	U Bolt M24 x 270mm Long	York Tecair II	
 <b>YK61SB506245/290</b>	U Bolt M24 x 290mm Long	York Tecair II	
 <b>YK61SB506245/320</b>	U Bolt M24 x 320mm Long	York Tecair I	
 <b>FP2826</b>	Hanger Front  Fabricated Design 2.4, 2.7 & 3.0 Metre Tri-Axle Spread	Fruehauf F Type Overslung	ULA 27721
 <b>FP2827</b>	Hanger Centre  Fabricated Design 2.4, 2.7 & 3.0 Metre Tri-Axle Spread	Fruehauf F Type Overslung	ULA27722

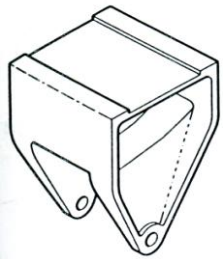
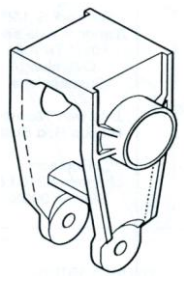
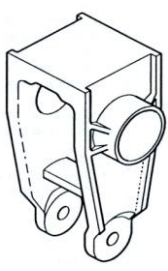

## Section 18 - Suspension Components

FPA No.	Description	Application	Alternate No.
 <b>FP2828</b>	Hanger Rear  Fabricated Design 2.4, 2.7 & 3.0 Metre Tri-Axle Spread	Fruehauf F Type Overslung  No Longer Available as Genuine Part.  Use GP Type Rear Hanger And Space With Packers To Required Height	ULA15196-1
 <b>FP6801</b>	Location: Front  Cast design Parallel Bush style in Torque Rod Mount area  2.4 Metre Tri-Axle Spread	Haulmark  8'1" Spread	Haulmark CS286 ITAL IT6801 Macteco 6801 Truckline FL92.2602
 <b>FP6802</b>	Location: Rear  Cast design  2.4 Metre Tri-Axle Spread	Haulmark  8'1" Tapered and Parallel	Haulmark CS287 ITAL IT6802
 <b>FP6803</b>	Location: Centre  Cast design Parallel Bush style in Torque Rod Mount area  2.4 Metre Tri-Axle Spread	Haulmark  (In centre equalising assembly)	Haulmark CS288 ITAL IT6803 Macteco 6803 Truckline FL92.2604
 <b>FP6903</b>	Location: Centre  Cast design Parallel Bush Style in Torque Rod Mount Area  2.4 Metre Tri-Axle Spread	Haulmark	Haulmark CS288 ITAL IT6903

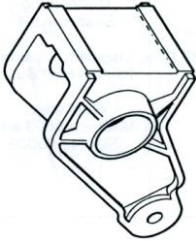
## Section 18 - Suspension Components

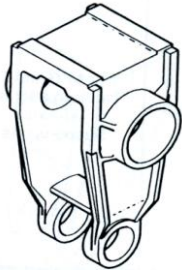
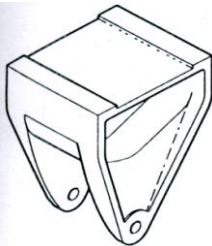
FPA No.	Description	Application	Alternate No.
 <p><b>FP7601</b></p>	<p>Location: Front</p> <p>Cast design Parallel Bush style in Torque Rod Mount area</p> <p>2.7 &amp; 3.1 Metre Tri-Axle Spread</p>	Haulmark	Haulmark CS271 ITAL IT7601
 <p><b>FP7603</b></p>	<p>Location: Centre</p> <p>Cast design Parallel Bush Style in Torque Rod Mount Area</p> <p>2.7 &amp; 3.1 Metre Tri-Axle Spread</p>	Haulmark  (In centre equalising assembly 9'1" & 10'1")	Haulmark CS274 ITAL IT7603 Macteco 7603 Truckline FL92.2606
 <p><b>FP8201</b></p>	<p>Location: Front</p> <p>Cast design</p> <p>Tapered Bush Style in Torque Rod Mount Area</p> <p>2.8 Metre Tri-Axle Spread</p>	Haulmark	Haulmark CS571 ITAL IT8201
 <p><b>FP8203</b></p>	<p>Location: Centre</p> <p>Cast design</p> <p>Tapered Bush Style in Torque Rod Mount Area</p> <p>2.5 Metre Tri-Axle Spread</p>	Haulmark	Haulmark CS588
 <p><b>FP82102</b></p>	<p>Location: Rear</p> <p>Cast design</p> <p>3.0 Metre Tri-Axle Spread</p>	Haulmark  10'1" & 9'1" Tapered and Parallel	Haulmark CS272 ITAL IT82102



## Section 18 - Suspension Components

FPA No.	Description	Application	Alternate No.
 <b>FP82103</b>	Location: Centre Cast design Tapered Bush Style in Torque Rod Mount Area 2.8 Metre Tri-Axle Spread	Haulmark	Haulmark CS574
 <b>YK59900001</b>	Location: Rear Cast design Fits all Spreads Single, Tandem and Tri-Axle, All Spreads	General Purpose Rubery Owen & Sinclair Overslung Suspension	Colrain SP3331 Haulmark CS287 ITAL IT6802 Macteco 8202 Truckline FL92.2601
 <b>YK59900022</b>	Location: Front Cast design Tapered Bush style in Torque Rod Mount area 2.4, 2.7 & 3.1 Metre Spread	General Purpose Rubery Owen & Sinclair Overslung Suspension	Haulmark CS586 ITAL IT8201 Macteco 8201 Truckline FL92.2600
 <b>YK59900026</b>	Location: Centre Cast design Tapered Bush style in Torque Rod Mount area 2.4 & 2.7 Metre Spread	General Purpose Rubery Owen & Sinclair Overslung Suspension (In centre equalising assembly)	Colrain SP1187 Haulmark CS588 ITAL IT8203 Macteco 8203 Truckline FL92.2603
 <b>YK59900032</b>	Location: Centre Cast design Tapered Bush style in Torque Rod Mount area 3.1 Metre Spread	General Purpose Rubery Owen & Sinclair Overslung Suspension (In centre equalising assembly)	Haulmark CS5745 ITAL IT82103 Macteco 82103 Truckline FL92.2605

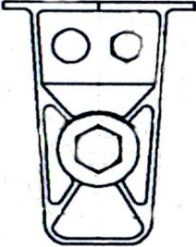
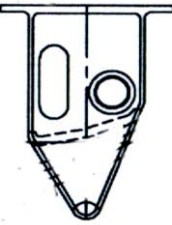
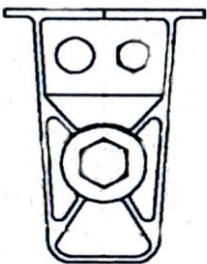
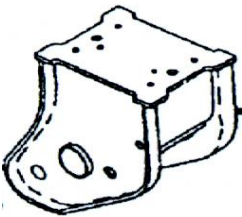

## Section 18 - Suspension Components

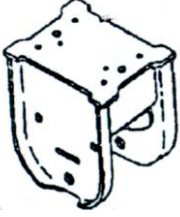
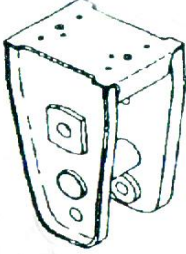
FPA No.	Description	Application	Alternate No.
 <b>YK59900035</b>	Location: Front  Cast design  Used For Drawbar Pull on Dolly's	York	
 <b>YK59900036</b>	Location: Centre  Cast design Tapered Bush style in Torque Rod Mount area  2.4 Metre Spread	York Underslung Suspension	ITAL IT8603 Macteco 8603
 <b>YK59900037</b>	Location: Front & Rear  Cast design Tapered Bush style in Torque Rod Mount area  2.4, 2.7 & 3.1 Metre Spread	York Underslung Suspension	ITAL IT8602 Macteco 8602
 <b>YK59900089</b>	Location: Centre  Cast design Tapered Bush style in Torque Rod Mount area  2.7 & 3.1 Metre Spread	York Underslung Suspension	
 <b>ZTE0084-00</b>	Location: Front	Reyco Transpro 88 Single Tandem Tri	

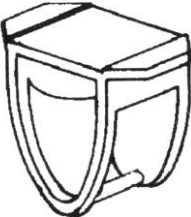
## Section 18 - Suspension Components

FPA No.	Description	Application	Alternate No.
 <b>ZTE0086-00</b>	Location: Rear	Reyco Transpro 88 & 89 Single Tandem Tri	
 <b>ZTE0088-00</b>	Location: Centre	Reyco Transpro 88 Tandem Tri	
 <b>ZTE20479-01</b>	Location: Front  Cast design Tapered Bush style in Torque Rod Mount area  2.4 Metre Tri-Axle Spread	Reyco 21B Series Overslung Trailer Suspension	ITAL LH: IT5257 RH: IT5258 Reyco LH: T5562 RH: T5563
 <b>ZTET5564</b>	Location: Centre  Cast design Tapered Bush style in Torque Rod Mount area  2.4 Metre Tri-Axle Spread	General Purpose Reyco 21B Series Overslung Trailer Suspension (In Centre Equalising Assembly)	ITAL IT5259 Reyco T5564
 <b>ZTET5565 (LHS)</b> <b>ZTET5566 (RHS)</b>	Location: Rear  Cast design  CAN USE ZTE20476-01	Reyco 21B Series Overslung Trailer Suspension	ITAL LH: IT5260 RH: IT5261 Reyco LH: T5565 RH: T5566

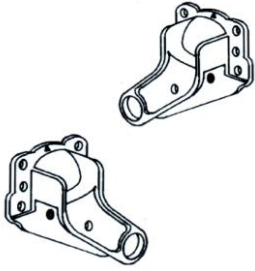
## Section 18 - Suspension Components

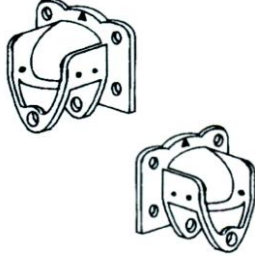
FPA No.	Description	Application	Alternate No.
 <p><b>ZTE22255-01 LH</b>  <b>ZTE22255-02 RH</b>  <b>ZTE21880-01 LH</b>  <b>ZTE21880-02 RH</b>  <b>ZTE22261-01 LH</b>  <b>ZTE22261-02 RH</b></p>	<p>Location: Front L &amp; R</p> <p>Cast design</p> <p>KW (Common)  KW (Common)  Volvo  Volvo  Ford  Ford</p>	<p>Reyco 102W Series  Truck Suspension</p> <p>KW (Common Spec Fits  the Following Makes)</p> <p>KW  Hino  Isuzi  Mitsubishi  Nissan  International  Scania</p>	<p>IT2884 RH (KW Spec)  IT2885 LH (KW Spec)</p>
 <p><b>ZTE22273-01</b>  <b>ZTE22277-01</b>  <b>ZTE22335-01</b></p>	<p>Location: Centre</p> <p>Cast design</p> <p>KW (Common)  Ford  Volvo</p>	<p>Reyco 102W Series  Truck Suspension</p> <p>KW (Common Spec Fits  the Following Makes)</p> <p>KW  Hino  Isuzi  Mitsubishi  Nissan  International  Scania</p>	<p>IT2886 (KW Spec)</p>
 <p><b>ZTE22300-01 RH</b>  <b>ZTE22300-02 LH</b>  <b>ZTE22303-01 LH</b>  <b>ZTE22303-02 RH</b>  <b>ZTE22297-01 LH</b>  <b>ZTE22297-02 RH</b></p>	<p>Location: Rear L &amp; R</p> <p>Cast design</p> <p>KW (Common)  KW (Common)  Volvo  Volvo  Ford  Ford</p>	<p>Reyco 102W Series  Truck Suspension</p> <p>KW (Common Spec Fits  the Following Makes)</p> <p>KW  Hino  Isuzi  Mitsubishi  Nissan  International  Scania</p>	<p>IT2887 LH (KW Spec)  IT2888 RH (KW Spec)</p>



# Section 19 - Air Springs

**PART No.**

**APPLICATION**

**FLEXIBLE MEMBER N ALTERNATE**

## AUSTRAL DENNING

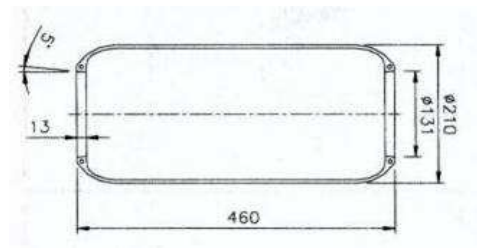
<p><b>GY8014</b></p> 	<p>Tourmaster, High Deck &amp; Double Deck Allstar Bus</p>	<p>566-03-8014 720N 1R2A-460-290 95 00 63</p>	<p>Contitech 720N EVO 02001/2 Iveco IT9058 M/Benz A387.328.01.01 Phoenix 1F21 Taurus B152 Taurus B154 (HT134629) York 61.610049</p>
--	--	---	---

## BPW

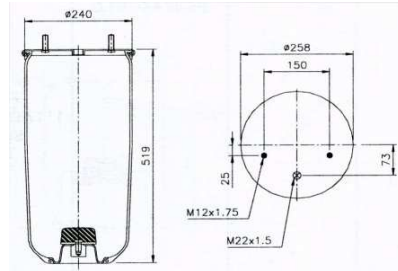
<p><b>0542942250 (GENUINE) GY1R11-700</b></p> 	<p>Type 30 BPW</p>	<p>941MB 566-22-3-500</p>	<p>BPW 0542942570 Contitech 941MB F/Stone 1T17D8.3M588620 Iveco IT9060G Phoenix 1D21, 1DK21 Powerdown ZPDBPW30 Taurus KR730-01 Taurus UR730-01</p>
--	--------------------	-------------------------------	--

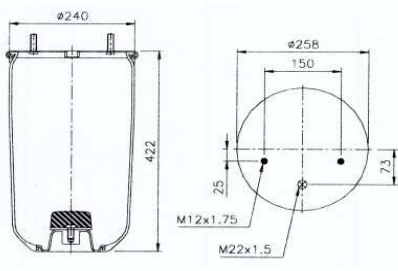
<p><b>0542942200 (GENUINE) GY1R11-703</b></p> 	<p>Type 30K BPW</p>	<p>940MB 566-22-3-501</p>	<p>BPW 0542942560 Contitech 940MB F/Stone 1T17D4.3M588613 Iveco IT9070G Phoenix 1DK21K Powerdown ZPDBPW30K Taurus R732, UR732-01T</p>
---	---------------------	-------------------------------	---

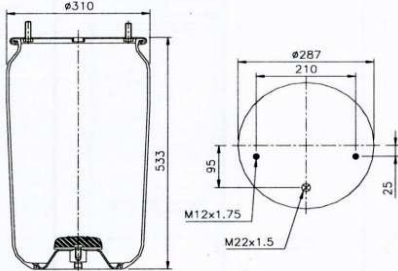
<p><b>0542942260 (GENUINE) GY1R14-708</b></p> 	<p>Type 36 BPW</p>	<p>881MB</p>	<p>BPW 0542942580 Contitech 881MB F/Stone 1T66E10.8M588978 Iveco IT9061G Phoenix 1D32, 1DK32 Powerdown ZPDBPW36 Taurus KR836-01T Taurus UR836-01</p>
---	--------------------	--------------	--

# Section 19 - Air Springs

**PART No.**

**APPLICATION**

**FLEXIBLE MEMBER N ALTERNATE**

## DAF

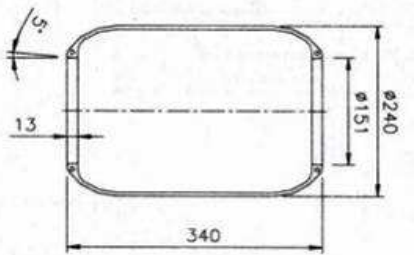
<p><b>GY8015</b></p> 		<p>556-03-8015</p>	<p>Contitech 715N DAF 4763473, 4456111 F/Stone 1R1C 335-310 95-0087 Iveco IT10027 Man 81.43601.0059/60/75... M/Benz A363.328.00.01 Phoenix 1F25 Taurus B144</p>
--	--	--------------------	---

## DENNIS

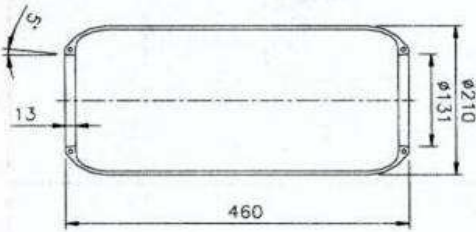
<p><b>GY8014</b></p> 	<p>Javelin Rear Dart SLF Front &amp; Rear</p>	<p>566-03-8014 720N 1R2A-460-290 95 0063</p>	<p>Contitech 720N EVO 02001/2 Iveco IT9058 M/Benz A387.328.01.01 Phoenix 1F21 Taurus B152 Taurus B154 (HT134629) York 61.610049</p>
---	---	--	---

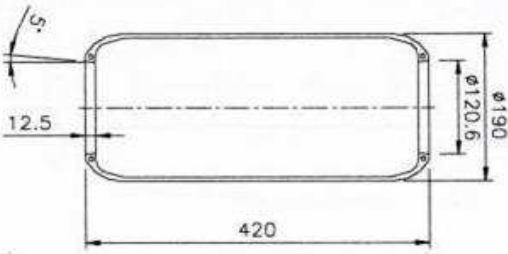
<p><b>GY8037</b></p> 	<p>Bus</p>	<p>556-03-8037</p>	<p>Contitech 927N F/Stone 1R1J 415-285 95 0188, 0244 Dennis 611896/12 Iveco IT10031 Leyland AA42542 Phoenix 2E1BE Taurus B179</p>
--	------------	--------------------	---

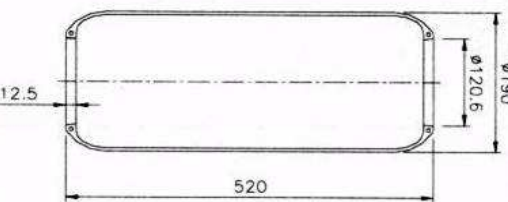
<p><b>GY8040</b></p> 	<p>K112 HDR K112 OR K112 TR K113DR</p>	<p>556-03-8040</p>	<p>Contitech 896N Dennis 0411627 F/Stone 1R1J520-285 095-0245 Iveco IT10023 Phoenix 2E18-A Scania 411627 Taurus B178</p>
--	--	--------------------	--



# Section 19 - Air Springs

PART No.

APPLICATION

FLEXIBLE MEMBER N ALTERNATE

## DOMINO

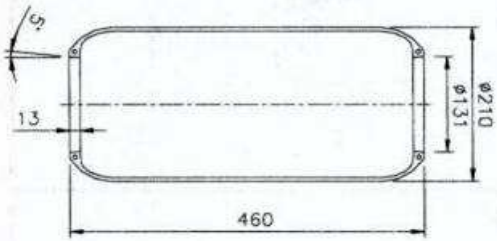
<p><b>GY8014</b></p> 	<p>Coach Front &amp; Rear</p>	<p>566-03-8014 720N 1R2A-460-290 95-0063</p>	<p>Contitech 720N EVO 02001/2 Iveco IT9058 M/Benz A387.328.01.01 Phoenix 1F21 Taurus B152 Taurus B154 (HT134629)</p>
--	-------------------------------	--	--

## EVOTRAC (SAME AS YORK FB)

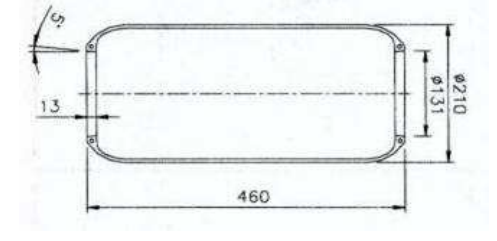
<p><b>GY8014</b></p> 	<p>Evotrac X400</p>	<p>566-03-8014 720N 1R2A-460-295-0063</p>	<p>Contitech 720N EVO 02001/2 Iveco IT9058 M/Benz A387.328.01.01 Phoenix 1F21 Taurus B152 Taurus B154 (HT134629) York 61.610049</p>
---	---------------------	---	---

## EVOTRAC (SAME AS YORK FB)

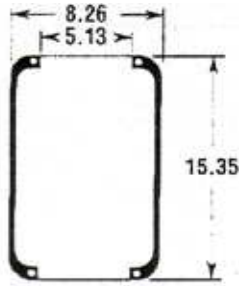
<p><b>GY8017E</b></p> 	<p>Evotrac X370</p>	<p>566-03-8017E  1R2A-390-295 95-0118</p>	<p>Contitech 644N EVO-02002/2 Iveco IT9059 Man 81.43601.0017 M/Benz 364.327.70.01 Phoenix 1E21 Taurus B121, BL121 Volvo 1134445 York 61.610050</p>
---	---------------------	---	--

## FREIGHTLINER

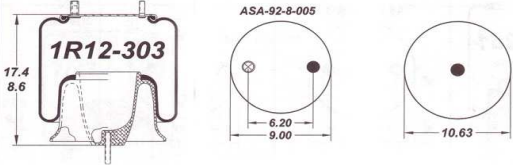
<p><b>GY1R12-303</b></p> 	<p>Airliner Heavy Duty (Composite Base)</p>	<p>566-24-3-275  IT15ZR-6  W01-358-9780</p>	<p>Firestone W01-385-9780, 9780 Freightliner 681-320-0017 Iveco IT9073 16-13810-000</p>
--	---	---	---

# Section 19 - Air Springs

**PART No.**

**APPLICATION**

**FLEXIBLE MEMBER # ALTERNATE**

## FREIGHTLINER

<p><b>GY1R12-603</b></p>	<p>Airliner Heavy Duty (Steel Base)</p>	<p>566-24-3-108  IT15ZR-6  W01-358-9780</p>	<p>Freightliner 681-320-0017 Iveco IT9073</p>
--------------------------	---	---	---

## FRUEHAUF

<p><b>GY1R12-279</b></p>		<p>566-24-3-066</p>	<p>Fruehauf UCE9393-2 Iveco IT10011</p>
--------------------------	--	---------------------	---

## FRUEHAUF

<p><b>GY1R12-281</b></p>	<p>TA, NT</p>	<p>566-24-3-066</p>	<p>Firestone 9130 Fruehauf UCE9393-1/3/4 Iveco IT9074</p>
--------------------------	---------------	---------------------	---

## HENDRICKSON HA SERIES

<p><b>GY1R8-009</b></p>	<p>HA150, HA350, HT150</p>	<p>566-16-3-011</p>	<p>Iveco IT9053</p>
-------------------------	----------------------------	---------------------	---------------------

# Section 19 - Air Springs

PART No.

APPLICATION

FLEXIBLE MEMBER / ALTERNATE

## HENDRICKSON HA SERIES

<p><b>GY1R12-365</b></p>	<p>HA200, 230, 400, 460 WD</p>	<p>566-24-3-038 566-24-3-074 566-24-3-225 1T15MT-6 F/Stone</p>	<p>Firestone W01-358-9466 Hendrickson 49048-002 Iveco IT9092 Mack 57QL411M Taurus KR504-04</p>
--------------------------	------------------------------------	--	--

<p><b>GY1R12-402</b></p>	<p>HAS231 (LOW PRO)</p>	<p>566-24-1-001  1T15-MT8</p>	<p>Hendrickson 50898-002 Iveco IT9086</p>
--------------------------	-------------------------	---------------------------------------	---

## HENDRICKSON HAS SERIES

<p><b>GY1R12-424</b></p>	<p>HA600</p>	<p>566-24-3-097 566-24-3-225</p>	<p>Hendrickson 50405 Iveco IT10012</p>
--------------------------	--------------	--------------------------------------	--

<p><b>HD57122-002</b></p>	<p>HAS200, 230, 231, 460, 461, W2-230, WD3, WD2-460, 461</p>	<p>566-24-1-097  1T15MT-8 F/Stone</p>	<p>Firestone W01-358-9373 Goodyear 1R12-403 Hendrickson 57122-002 Iveco IT10006</p>
---------------------------	--	---	---

# Section 19 - Air Springs

PART No.

APPLICATION

FLEXIBLE MEMBER / ALTERNATE

## HENDRICKSON HAS SERIES

<p>HD58849-002</p> <p style="text-align: center; color: red; font-weight: bold;">IMAGE UNAVAILABLE</p>	<p>HAS400 (LOW PRO)</p>	<p>1T15MT4 F/Stone</p>	<p>Hendrickson 58849-002</p>
--	-------------------------	------------------------	------------------------------

## HENDRICKSON HT/T SERIES

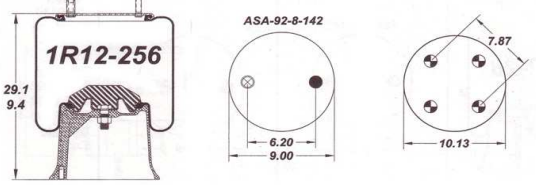
<p>GY1R12-256</p> 	<p>HT250U-7.5-021</p>	<p>566-24-3-090</p> <p>IT15M-11 F/Stone</p>	<p>Hendrickson C-14249 Hendrickson S-14249 Iveco IT9099</p>
--	-----------------------	---	---

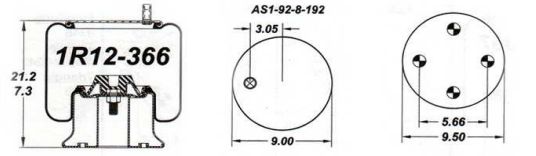
<p>GY1R12-366</p> 	<p>HT190U</p>	<p>566-24-3-038</p> <p>1T15MLW-7 1T15LP-6 F/Stone</p>	<p>Firestone W01-358-8944 Firestone W01-358-9015 Hendrickson C-20217 Iveco IT9096</p>
---	---------------	---	---

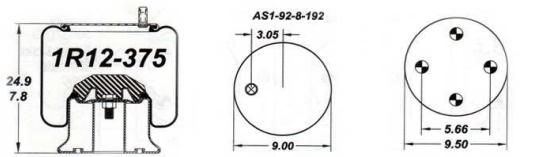
<p>GY1R12-375</p> 	<p>HT250T/HT250U 160, 190, 228mm Ride Height</p>	<p>566-24-3-066</p> <p>1T15MM-9 F/Stone</p>	<p>Firestone W01-358-9265 Hendrickson C-20124 Iveco IT9094</p>
---	--	---	--

# Section 19 - Air Springs

PART No.

APPLICATION

FLEXIBLE MEMBER N ALTERNATE

## HENDRICKSON HT/T SERIES

<p><b>GY1R12-509</b></p>	<p>T9-106U/S, T23-US-6</p>	<p>566-24-3-038  1T16-M6</p>	<p>Hendrickson B-2066</p>
<p><b>GY1R13-038</b></p>	<p>HT300U</p>	<p>566-26-3-015 566-26-3-072</p>	<p>Firestone 9122 Hendrickson B-3830 Hendrickson C-22173 Iveco IT9090 Neway 90557020, 71, 76, 77 Reyco 12883-02 Ridewell S-3053-C</p>
<p><b>GY1R13-118</b></p>	<p>HT250US 165, 190, 228, 305mm Ride Height</p>	<p>566-26-3-039  1T15MLW-7</p>	<p>Firestone W01-358-9580 Hendrickson C-20127 Iveco IT9095</p>
<p><b>GY1R13-119</b></p>	<p>HT230T</p>	<p>566-26-3-036/053  DUAL STUD SINGLE STUD  1T15VM-4 IT15VP-4</p>	<p>Firestone W01-358-9270 Hendrickson S-21208 Hendrickson C-21208 Hendrickson C-20010 Iveco IT9072 Reyco 23433-01 Taurus KR501-01</p>

# Section 19 - Air Springs

PART No.

APPLICATION

FLEXIBLE MEMBER N ALTERNATE

## HENDRICKSON HT/T SERIES

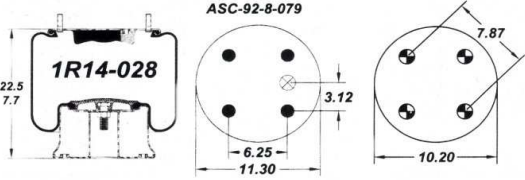
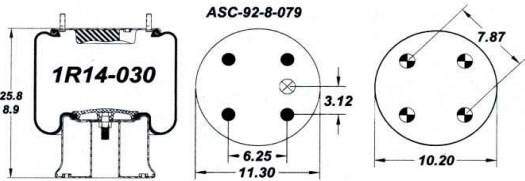
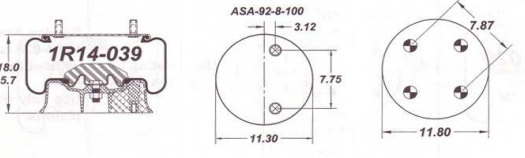
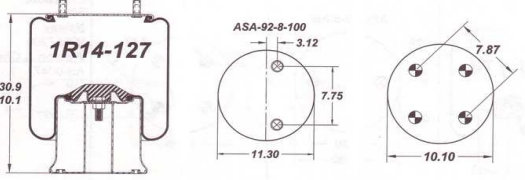
<p><b>GY1R14-028</b></p> 	<p>Hendrickson</p>	<p>566-28-3-021</p>	<p>Hendrickson B-2065</p>
<p><b>GY1R14-030</b></p> 	<p>Hendrickson</p>	<p>566-28-3-020</p>	<p>Hendrickson B-2063</p>
<p><b>GY1R14-039</b></p> 	<p>T15, T17, HT300T</p>	<p>566-28-3-015 566-28-3-023 1T19J-6 F/Stone</p>	<p>Firestone W01-358-8050 Hendrickson S-4771, B-4771 ITAL 1685174C1 Iveco IT9091</p>
<p><b>GY1R14-127</b></p> 	<p>HT250U-9-021</p>	<p>566-28-3-031 1T19F-14</p>	<p>Hendrickson C-13122</p>

# Section 19 - Air Springs

PART No.

APPLICATION

FLEXIBLE MEMBER # ALTERNATE

## HENDRICKSON HT/T SERIES

<p><b>GY2B9-201</b></p>	<p>HLM LIFT Suspension</p>	<p>578-92-3-202</p>	<p>Hendrickson B-2630 Iveco IT10001</p>
<p><b>GY2B10-226</b></p>	<p>Paralift Suspension</p>	<p>578-92-3-250</p>	<p>Iveco IT9087</p>
<p><b>GY2B12-324</b></p>	<p>HTCL-004, HLM Lift Suspension</p>	<p>578-92-3-310</p>	<p>Hendrickson S-14318 Iveco IT9093</p>
<p><b>GY3B12-312</b></p>	<p>Paralift PAR001</p>	<p>578-93-3-100</p>	<p>Hendrickson B-14487 Iveco IT9088</p>

# Section 19 - Air Springs

**PART No.**

**APPLICATION**

**FLEXIBLE MEMBER / ALTERNATE**

## HENDRICKSON INTRAAX

<p><b>HDS-23612</b></p>			<p>Firestone W01-358-9645 Hendrickson C-23612 Hendrickson S-23612</p>
-------------------------	--	--	---

<p><b>HDS-23721</b></p>		<p>IT15MTW-6</p>	<p>Firestone W01-358-9644</p>
-------------------------	--	------------------	-------------------------------

<p><b>GY1R13-159</b></p>	<p>AA230 Maxitraax</p>	<p>566-26-3-073 1T17-B5 F/Stone 1T17-C5 F/Stone</p>	<p>Firestone 8709, 8751 Hendrickson C-20900 Hendrickson S-21800 Iveco IT9097</p>
--------------------------	----------------------------	---	--

<p><b>GY1R14-171</b></p>	<p>AA250</p>	<p>566-28-3-015</p>	<p>Firestone W01-358-8091 Firestone 1T19-FC5 Firestone 1T19LC-6 Hendrickson C-20901 Hendrickson C-21784 Iveco IT9098</p>
--------------------------	--------------	---------------------	--



# Section 19 - Air Springs

**PART No.**

**APPLICATION**

**FLEXIBLE MEMBER N ALTERNATE**

## HINO

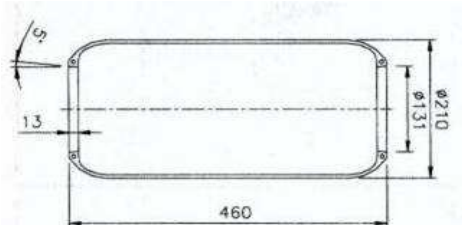
<p><b>GY8014</b></p> 	<p>RK176, RM197 Bus</p>	<p>566-03-8014 720N 1R2A-460-290 95 00 63</p>	<p>Contitech 720N EVO 02001/2 Iveco IT9058 M/Benz A387.328.01.01 Phoenix 1F21 Taurus B152 Taurus B154 (HT134629) York 61.610049</p>
--	-------------------------	---	---

## HOLLAND

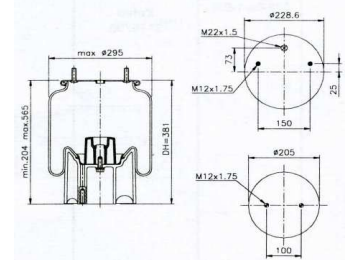
<p><b>GY1R11-111</b></p> 	<p>Holland Euro &amp; Ultra Lite Series</p>	<p>566-22-3-521  1T15MP7-6297 1T15MP7-7364</p>	<p>Contitech 4157N P04 Firestone W01-358-6297 Firestone 3052 OR 7364 Iveco IT9071 Phoenix 1DK21A-8 RFS:29-5034A ROR: 2501202 ROR:21221307</p>
---	---	--	---

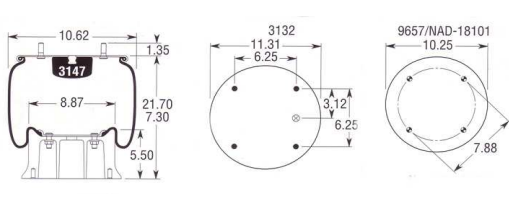
<p><b>GY1R14-716</b></p> 	<p>Holland AIR HD Sies</p>	<p>566-28-3-021  1T19F-7/1T19L7 1T19F-7/1T19L7</p>	<p>Contitech 810MB 4 STUDS Firestone W01-358-9177 &amp; 8775 Firestone W01-358-9179 &amp; 7337 Holland 21208062 Iveco IT9056 Phoenix 1DK-28B, 1D28A2 Powerdown 1D28G-26 ROR 2501201 Taurus B621, K621-26 York 506243/01</p>
--	----------------------------	--	---

## INTERNATIONAL

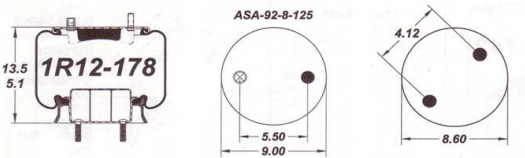
<p><b>GY1R12-178</b></p> 	<p>AIR Ride Various ITAL</p>	<p>566-24-3-067  1T15L-2.5X 1T15LC-2.5 F/Stone</p>	<p>Firestone W01-358-9379 ITAL 1660694C1</p>
--	------------------------------	--	--

# Section 19 - Air Springs

**PART No.**

**APPLICATION**

**FLEXIBLE MEMBER # ALTERNATE**

## INTERNATIONAL

<p><b>GY1R12-401</b></p>	<p>AIR Ride Various ITAL 6X4</p>	<p>566-24-1-000 566-24-3-038  1T15MT-8-9213 1T15M-6-9213 F/Stone</p>	<p>Firestone W01-358-9371 Firestone W01-358-9213 ITAL 1686386C1 ITAL 501559C2 ITAL1670043C1</p>
--------------------------	--------------------------------------	--	---

<p><b>GY1R14-160</b></p>	<p>Navistar</p>	<p>566-28-3-021</p>	<p>Firestone W01-358-9144 Iveco IT9081 Neway 90557155</p>
--------------------------	-----------------	---------------------	---

<p><b>GY1S4-007</b></p>	<p>Cab Rear</p>	<p>ASC-08-7-139</p>	<p>Firestone 7031 ITAL 3261050R1 Iveco FP9054 Link 1101-0020 Mack 227QS33</p>
-------------------------	-----------------	---------------------	---

## IVECO

<p><b>GY1R12-351</b></p>	<p>MP4500 8X4</p>	<p>566-24-3-061</p>	<p>Iveco 97134282</p>
--------------------------	-------------------	---------------------	-----------------------

# Section 19 - Air Springs

**PART No.**

**APPLICATION**

**FLEXIBLE MEMBER # ALTERNATE**

## IVECO

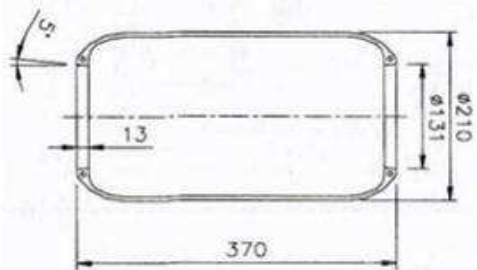
<p><b>GY8012</b></p> 	Eurocargo	556-03-8012	Contitech 944N F/Stone 1R1A 370-285 95-0198 Iveco 4714025, 4716989, 4738008 Iveco IT10002
--	-----------	-------------	--

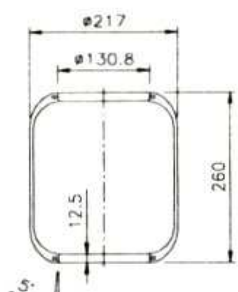
<p><b>GY9001</b></p> 	MP4500 Eurotech	556-03-9001	Contitech 943N F/Stone 1R1A 260-285 95-0189 Iveco 8160165, 6144040 Iveco IT10004 Taurus B194
---	-----------------	-------------	--

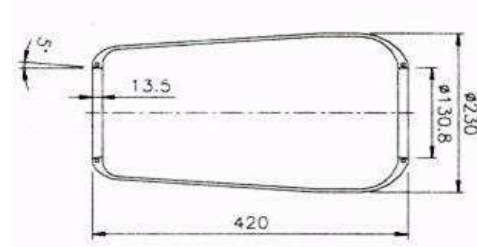
<p><b>GY9002</b></p> 	Eurocargo	556-03-9002	Contitech 884N Iveco 8188539 Iveco IT10003 M/Benz A6583280001 Man 81.43601.0066/68/69/106/108/... Phoenix 1F20B-2 Taurus BL249
--	-----------	-------------	--

## KENWORTH

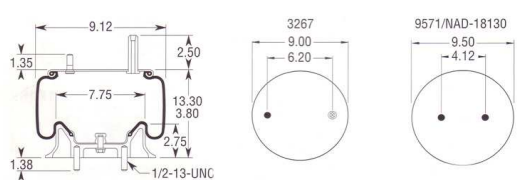
<p><b>FP9066</b></p> 	Airglide 100 8 Bag Late Version with Top Bracket	1T15L-1.5 OR 1T15KW-1.5	Firestone W01-358-9616 Goodyear 1R11-078 NLA Iveco IT9066 Kenworth K303-16
--	--	----------------------------	---

# Section 19 - Air Springs

**PART No.**

**APPLICATION**

**FLEXIBLE MEMBER # ALTERNATE**

## KENWORTH

<p><b>GY1R11-028</b></p>	<p>Airglide 100 8 Bag Early Version Less Top Bracket</p>	<p>566-22-3-021  1T15L-1.5 OR 1T15KW-1.5</p>	<p>Firestone W01-358-9422 ITAL 554762C1 Iveco IT9050 Kenworth K303-6 Kenworth K303-14 Kenworth K303-15</p>
--------------------------	--	--	--

<p><b>GY1R11-018</b></p>	<p>4 Bag</p>	<p>566-22-3-006</p>	<p>Kenworth K374-9</p>
--------------------------	--------------	---------------------	------------------------

<p><b>GY1R11-219</b></p>	<p>8 Bag</p>	<p>566-22-3-021</p>	<p>Firestone W01-358-9617 Iveco IT10045 Kenworth K303-18</p>
--------------------------	--------------	---------------------	--

<p><b>GY1R11-220</b></p>	<p>8 Bag Late</p>	<p>566-22-3-021</p>	<p>Firestone W01-358-9618 Iveco IT10046 Kenworth K303-19 IT15KW-O</p>
--------------------------	-------------------	---------------------	---

# Section 19 - Air Springs

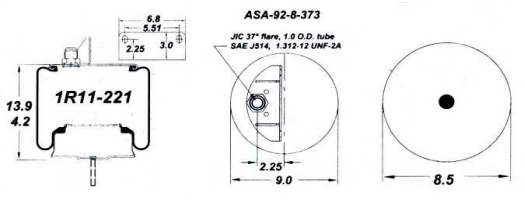
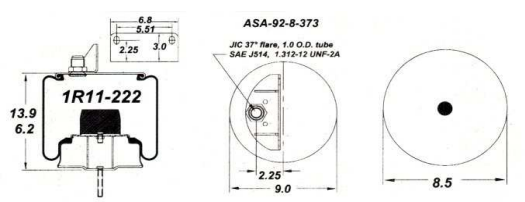
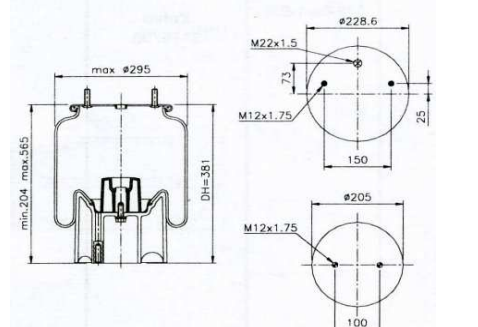
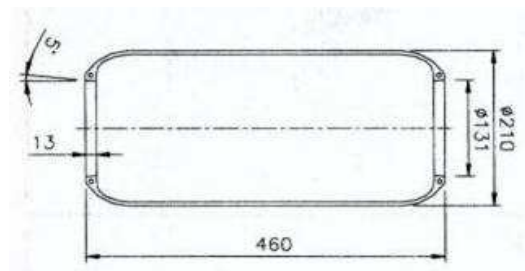
PART No.	APPLICATION	FLEXIBLE MEMBER N	ALTERNATE
<p><b>KENWORTH</b></p> <p><b>GY1R11-221</b></p> 	<p>8 Bag Late Airslide 200</p>	<p>566-22-3-021</p>	<p>Firestone W01-358-9622 Kenworth K303-22 Iveco IT9079</p>
<p><b>GY1R11-222</b></p> 	<p>8 Bag Late Airslide 200</p>	<p>566-22-3-021</p>	<p>Firestone W01-358-9625 Kenworth K303-25 Iveco IT9080 IT15KW-O</p>
<p><b>KRUEGER (ALSO WEWELLER)</b></p>			
<p><b>GY1R11-111</b></p> 	<p>RFS2000</p>	<p>566-22-3-521</p> <p>Firestone: 1T15MP7-6297 1T15MP7-7364</p>	<p>Contitech 4157N P04 Firestone W01-358-6297 Firestone 3052 OR 7364 Iveco IT9071 Krueger 295034-A Phoenix 1DK21 A-8 RFS:29-5034A ROR: 2501202 ROR:21221307 Taurus KR915-54</p>
<p><b>MAN</b></p>			
<p><b>GY8014</b></p> 	<p>22.372 , 22.180 (R/T)</p>	<p>566-03-8014</p> <p>Firestone 1R2A-390-290 95 00 63</p>	<p>Contitech 720N Iveco IT9058 Man 81.43601.0033, 36, 37 M/Benz A3873280101 Phoenix 1F21 Taurus B152 Taurus B154 (HT134629) Volvo 1629193 York 61.610049</p>

# Section 19 - Air Springs

PART No.

APPLICATION

FLEXIBLE MEMBER N ALTERNATE

**MAN**

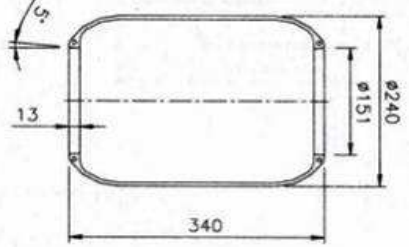
<p><b>GY8015</b></p> 		<p>556-03-8015</p>	<p>Contitech 715N DAF 4763473, 4456111 F/Stone 1R1C 335-310 95-0087 Iveco IT10027 Man 81.43601.0059/60/75... M/Benz A363.328.00.01 Phoenix 1F25 Taurus B144</p>
--	--	--------------------	---

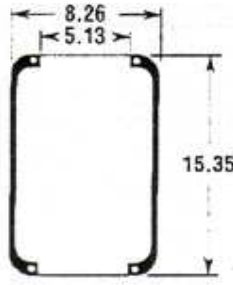
<p><b>GY8017E</b></p> 		<p>566-03-8017E</p> <p>1R2A-390-295 95-0118</p>	<p>Contitech 644N EVO-02002/2 Iveco IT9059 Man 81.43601.0017 M/Benz 364.327.70.01 Phoenix 1E21 Taurus B121, BL121 Volvo 1134445 York 61.610050</p>
--	--	---	--

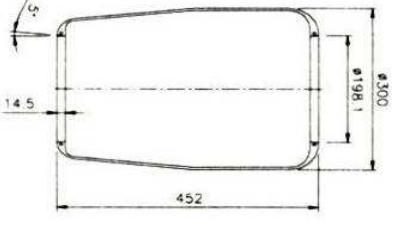
<p><b>GY8117</b></p> 		<p>556-03-8117</p>	<p>Contitech 727N F/Stone 1R2D 460-360 95-0204 Iveco IT10029 Man 81.43601.0082 M/Benz 307.328.01.01 Phoenix 1F32A Taurus B149 Volvo 1134446</p>
--	--	--------------------	---

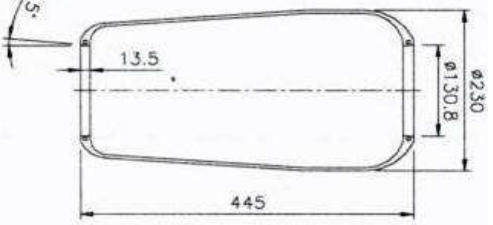
<p><b>GY9003</b></p> 		<p>556-03-9003</p>	<p>Contitech 1884N1, 1885N1 Iveco 98478799 Iveco IT10033 Man 81.43601.0150 Phoenix 1F20B-1</p>
--	--	--------------------	--

# Section 19 - Air Springs

**PART No.**

**APPLICATION**

**FLEXIBLE MEMBER N ALTERNATE**

## MAN

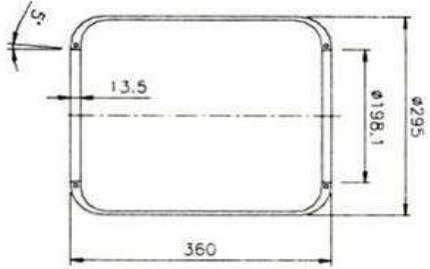
<p><b>GY9007</b></p> 		<p>566-03-9007</p>	<p>Contitech 662N          F/Stone 1R1D 355-355 95-0030          Iveco IT10026          Man 81.43601.0018          Phoenix 1E32          Taurus B114</p>
--	--	--------------------	--

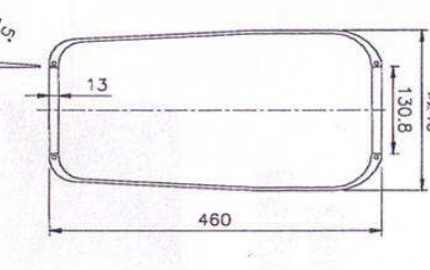
<p><b>GY9015</b></p> 		<p>566-03-9015</p>	<p>Contitech 916N1          Man 81.43601.0095, 97,102, 105, 126          Phoenix 1F21C-5          Taurus B154</p>
---	--	--------------------	---

## MAXITRANS

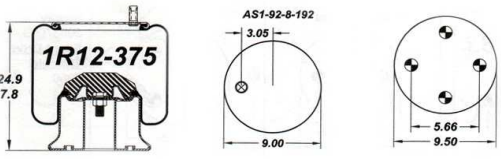
<p><b>GY1R12-375</b></p> 	<p>Overslung</p>	<p>566-24-3-066</p>	<p>Firestone W01-358-9265          Hendrickson C-20124          Iveco IT9094</p>
--	------------------	---------------------	--

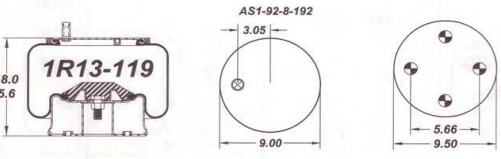
<p><b>GY1R13-119</b></p> 	<p>Underslung</p>	<p>566-26-3-036/053</p>	<p>Firestone W01-358-9270          Hendrickson S-21208          Hendrickson C-20010          Iveco IT9072          Reyco 23433-01          Taurus KR501-01</p>
--	-------------------	-------------------------	--

# Section 19 - Air Springs

PART No.

APPLICATION

FLEXIBLE MEMBER N ALTERNATE

## M.C.A

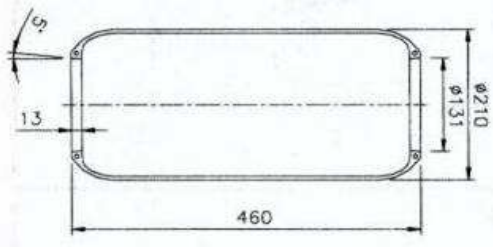
<p>GY8014</p> 	<p>Front &amp; Rear Bus</p>	<p>566-03-8014 720N 1R2A-460-290 95-0063</p>	<p>Contitech 720N EVO 02001/2 Iveco IT9058 M/Benz A387.328.01.01 Phoenix 1F21 Taurus B152 Taurus B154 (HT134629) York 61.610049</p>
---	-----------------------------	--	---

## MERCEDES BENZ

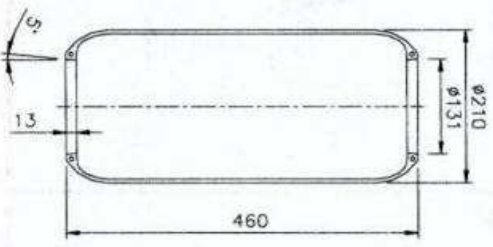
<p>GY8014</p> 		<p>566-03-8014 720N 1R2A-460-290 95-0063</p>	<p>Contitech 720N EVO 02001/2 Iveco IT9058 Man 81.43601.0033, 36, 37 M/Benz A387.328.01.01 Phoenix 1F21 Taurus B152 Taurus B154 (HT134629) Volvo 1629193 York 61.610049</p>
--	--	--	---

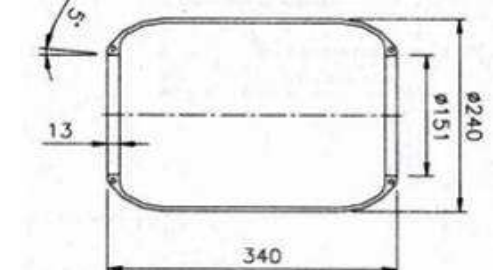
<p>GY8015</p> 		<p>556-03-8015</p>	<p>Contitech 715N DAF 4763473, 4456111 F/Stone 1R1C 335-310 95-0087 Iveco IT10027 Man 81.43601.0059/60/75... M/Benz 363.328.00.01 Phoenix 1F25 Taurus B144</p>
---	--	--------------------	--

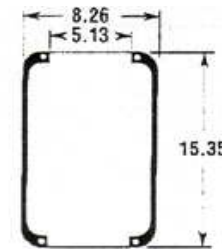
<p>GY8017E</p> 	<p>1418, O 303, O 305, OH 1425, OH 1630 (F), 302, 303, 305, 307, 0400 UP, 0405 (F/R)</p>	<p>556-03-8017E  1R2A-390-295 95-0118</p>	<p>Contitech 644N EVO-02002/2 Iveco IT9059 Man 81.43601.0017 M/Benz 364.327.70.01 Phoenix 1E21 Taurus B121, BL121 Volvo 1134445</p>
--	--	---	---

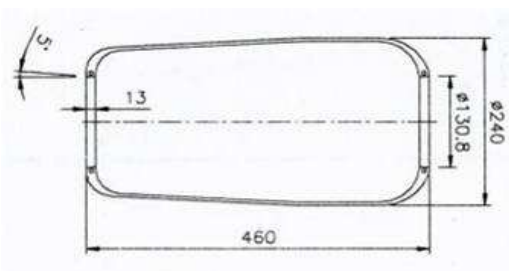

# Section 19 - Air Springs

PART No.	APPLICATION	FLEXIBLE MEMBER NUMBER ALTERNATE	
<p><b>GY9008</b></p> 	<p>1017 LS 1217 L 1419/1420/1422/1425/ 1524/1613/1617/1620/ 1622/1624/1625/1626/ 162801632/1633/1635/ 1928/1932/2219/2220/ 2222/2224/2226/2228/ 2232/2233/2235/2238/ 2244/2252/2624/709/813</p>	<p>566-03-9008</p>	<p>Contitech 720N F/Stone 1R2A 460-295 95-0195 Iveco IT10028 Man 81.43601.0033/36/37 M/Benz 387.328.0101 M/Benz 387.328.0001 Phoenix 1F21 Taurus B152 Volvo 1590136, 1622115</p>

## MERITOR

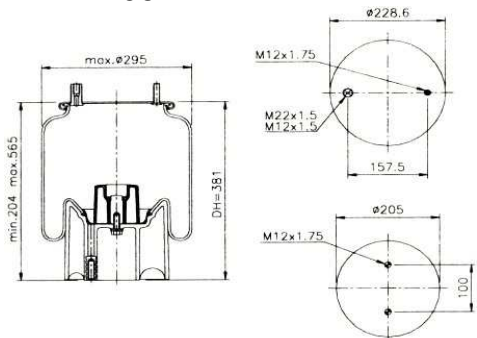
<p><b>GY1R11-106</b></p> 	<p>9 Tonne</p>	<p>566-22-3-521</p> <p>Firestone: 1T15MPW-7 M58-7074</p>	<p>Contitech 4157 N P09 Firestone 3053 Iveco IT10008 S/S TO IT10021 Phoenix 1DK21 A-3 ROR 21222442 Taurus KR913-57</p>
---	----------------	--	--

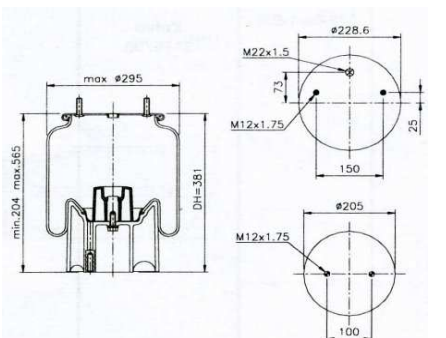
<p><b>GY1R11-111</b></p> 	<p>Flexair FL9000 After Apr-99</p>	<p>566-22-3-521</p> <p>1T15MP7-6297 1T15MP7-7364</p>	<p>Contitech 4157N P04 Firestone W01-358-6297 Firestone 3052 OR 7364 Iveco IT9071 Krueger 295034-A Phoenix 1DK21A-8 RFS:29-5034A ROR: 2501202 ROR:21221307 Taurus KR915-54</p>
--	------------------------------------	--	--

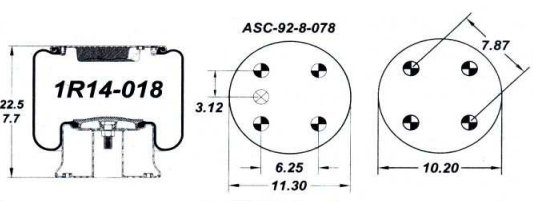
<p><b>GY1R14-018</b></p> 	<p>Flexair</p>	<p>566-28-3-021</p>	<p>Firestone 9148 Iveco IT9082 Taurus K621-9149</p>
--	----------------	---------------------	---

# Section 19 - Air Springs

**PART No.**

**APPLICATION**

**FLEXIBLE MEMBER # ALTERNATE**

## MERITOR

<p><b>GY1R14-721</b></p>	<p>ROR Flexair FL11000 &amp; FL11000L (Meritor)</p>	<p>566-28-3-503</p>	<p>Firestone 1T19L-11M58 7370 Meritor 2122239</p>
--------------------------	---	---------------------	---

## NEWAY (TRUCK)

<p><b>NE90557161</b></p>	<p>AD200</p>	<p>1T15M-4</p>	<p>Firestone W01-358-9483 Neway 90557161</p>
--------------------------	--------------	----------------	--

<p><b>GY1R12-092</b></p>	<p>ARD-244, ARDST-244, SA38(ARD), SA44(ARDST)</p>	<p>566-24-3-038  1T15M-6 OR 1T15K-1</p>	<p>Firestone W01-358-9082 Firestone 1TSK1M-6-9082 Hendrickson B-2066, S-2066 Iveco IT9055, IT9089 Neway 90557006, 27,37, 54 57 Phoenix KR602-9082 Reyco 12882-01 York 61.610121</p>
--------------------------	---	---	---

<p><b>GY1R12-484</b></p>	<p>AD246 (Mack)</p>	<p>566-24-3-038</p>	<p>Iveco IT9075 Neway 90557215</p>
--------------------------	---------------------	---------------------	--

# Section 19 - Air Springs

**PART No.**

**APPLICATION**

**FLEXIBLE MEMBER / ALTERNATE**

## NEWAY (TRUCK)

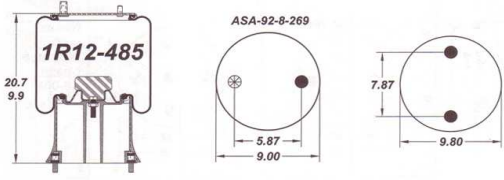
<p><b>GY1R12-485</b></p> 	<p>Neway</p>		<p>Firestone W01-358-9504 Neway 90557214</p>
--	--------------	--	--

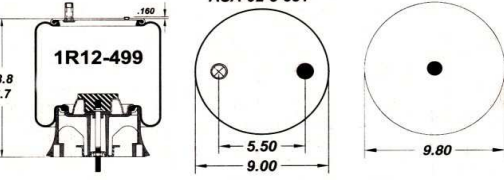
<p><b>GY1R12-499</b></p> 	<p>RL228-15, RL250-15</p>	<p>566-24-3-038</p>	<p>Neway 90557156</p>
---	---------------------------	---------------------	-----------------------

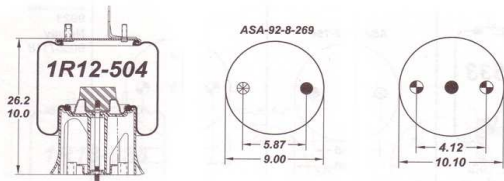
<p><b>GY1R12-504</b></p> 	<p>AD123, AD246-10 10" Ride Height</p>	<p>566-24-3-066 1T15V-8-9471</p>	<p>Firestone W01-358-9781 Iveco IT9077 Neway 90557146</p>
--	--	--------------------------------------	---

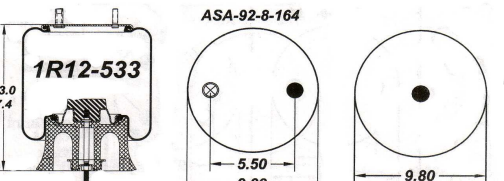
<p><b>GY1R12-533</b></p> 	<p>AD123 AND AD246 6.5" &amp; 8.75" Ride Height</p>	<p>566-24-3-097</p>	<p>566-242-373-10000 Neway 90557118</p>
--	---	---------------------	---

# Section 19 - Air Springs

**PART No.**

**APPLICATION**

**FLEXIBLE MEMBER / ALTERNATE**

## NEWAY (TRUCK)

<p><b>GY1R12-552</b></p>	<p>AD246-10"</p>	<p>566-24-3-038</p> <p>Firestone: 1T15V-8</p>	<p>Firestone 0756, 9471 Iveco IT10005 Iveco IT9085 Neway 90557212</p>
--------------------------	------------------	---	---

<p><b>GY1R12-553</b></p>	<p>AD123 AND AD246 6.5" &amp; 8.75" Ride Height</p>	<p>566-24-3-038</p> <p>1T15K1-9472 1T15V-8</p>	<p>Firestone W01-358-9472 Iveco IT100020 Neway 90557213 Neway 90557147</p>
--------------------------	---	--	--

<p><b>GY1R12-554</b></p>	<p>Neway</p>	<p>566-24-3-038</p>	<p>Iveco IT10014 Neway 90557211</p>
--------------------------	--------------	---------------------	---

<p><b>GY1R12-586</b></p>	<p>Neway</p>	<p>566-24-3-038</p> <p>F/Stone 1T17B-5</p>	<p>Firestone 9473 Neway 90557152</p>
--------------------------	--------------	--	--

# Section 19 - Air Springs

PART No.

APPLICATION

FLEXIBLE MEMBER # ALTERNATE

## NEWAY (TRUCK)

<p><b>GY1R13-152</b></p>	<p>AR240-14 &amp; 15</p>	<p>566-26-3-071  (F/Stone 1T17B-11)</p>	<p>Firestone W01-358-8748 Iveco IT10016 Neway 90557167</p>
--------------------------	--------------------------	---	--

<p><b>GY1R13-153</b></p>	<p>RLU250-12-16-17</p>	<p>566-26-3-071</p>	<p>Neway 90557168</p>
--------------------------	------------------------	---------------------	-----------------------

## NEWAY (TRAILER)

<p><b>GY1R12-092</b></p>		<p>566-24-3-038  1T15M-6 OR 1T15K-1</p>	<p>Firestone W01-358-9082 Firestone 1TSK1M-6-9082 Hendrickson B-2066, S-2066 Iveco IT9055 Iveco IT9089 Neway 90557006 Phoenix KR602-9082 Reyco 12882-01 York 61.610121</p>
--------------------------	--	---	--

<p><b>GY1R12-095</b></p>	<p>AR45</p>	<p>566-24-3-067</p>	<p>Contitech 4150 N P04 Firestone 1T15M-03589039 Firestone 9039, 9307 Iveco IT10019 Neway 90557023 Taurus KR500-22 SU</p>
--------------------------	-------------	---------------------	---

# Section 19 - Air Springs

PART No.

APPLICATION

FLEXIBLE MEMBER N ALTERNATE

## NEWAY (TRAILER)

<p><b>GY1R12-103</b></p>	<p>AR75-12</p>	<p>566-24-3-066</p>	<p>Firestone W01-358-9101 Hendrickson B-3842 Neway 90557009</p>
--------------------------	----------------	---------------------	---

<p><b>GY1R12-167</b></p>	<p>AR90 14-15" Ride Height</p>	<p>566-24-3-066  1T15M-9</p>	<p>Firestone W01-358-8855 Iveco IT10010 Neway 90557086</p>
--------------------------	------------------------------------	--------------------------------------	--

<p><b>GY1R12-441</b></p>	<p>AR75 (-6, -9)</p>	<p>566-24-3-038</p>	<p>Neway 90557113</p>
--------------------------	----------------------	---------------------	-----------------------

<p><b>GY1R12-480</b></p>	<p>AR90-14</p>	<p>566-24-3-066</p>	<p>Neway 90557112</p>
--------------------------	----------------	---------------------	-----------------------

# Section 19 - Air Springs

PART No.

APPLICATION

FLEXIBLE MEMBER N ALTERNATE

## NEWAY (TRAILER)

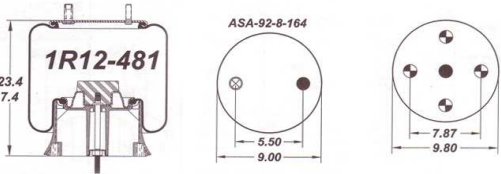
<p><b>GY1R12-481</b></p> 	<p>AR92-15, AR93-16, ARU93-8</p>	<p>566-24-3-097</p>	<p>Iveco IT9078 Neway 90557118</p>
--	--------------------------------------	---------------------	--

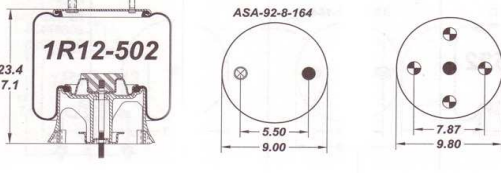
<p><b>GY1R12-502</b></p> 	<p>AR92-12-14, ARU92-8</p>	<p>566-24-3-097</p>	<p>Iveco IT9076 Neway 90557117</p>
---	----------------------------	---------------------	--

## PETERBUILT

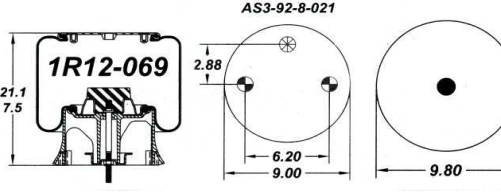
<p><b>GY1R12-069</b></p> 	<p>Air Track Suspension</p>	<p>566-24-3-038</p>	<p>Iveco IT10007</p>
--	-----------------------------	---------------------	----------------------

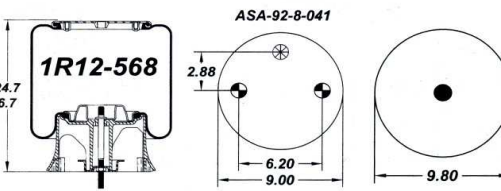
<p><b>GY1R12-568</b></p> 		<p>566-24-3-066</p>	<p>Iveco IT9084 Peterbuilt 03.07887</p>
--	--	---------------------	---

# Section 19 - Air Springs

**PART No.**

**APPLICATION**

**FLEXIBLE MEMBER # ALTERNATE**

**REYCO**

<p><b>FP23521-01</b></p>	<p>25ARUU (Trailer)</p>	<p>1T15M-9</p>	<p>Firestone W01-358-8855 Iveco IT10010 Reyco 23521-01</p>
--------------------------	-------------------------	----------------	--

<p><b>GY1R12-092</b></p>	<p>102AR Truck</p>	<p>566-24-3-038  Firestone: 1T15M-6 OR 1T15K-1</p>	<p>Firestone W01-358-9082 Firestone 1TSK1M-6-9082 Hendrickson B-2066, S-2066 Iveco IT9055 Iveco IT9089 Neway 90557006 Phoenix KR602-9082 Reyco 12882-01 York 61.610121</p>
--------------------------	--------------------	--	--

<p><b>GY1R12-188</b></p>	<p>102AR (Truck)</p>	<p>566-24-3-038  F/Stone 1T15M-6 1T15L-8X</p>	<p>Firestone W01-358-9223 Iveco IT9064 Reyco 12884-01</p>
--------------------------	----------------------	---	---

<p><b>GY1R12-421</b></p>	<p>87AR 102AR (Truck)</p>	<p>566-24-3-076  F/Stone 1T15M-9</p>	<p>Firestone W01-755-9010 Reyco 12928-01</p>
--------------------------	-------------------------------	--	--



# Section 19 - Air Springs

**PART No.**

**APPLICATION**

**FLEXIBLE MEMBER / ALTERNATE**

## REYCO

<p><b>GY1R13-119</b></p>	<p>23ARTU-AUS</p>	<p>566-26-3-036 1T17B-5</p>	<p>Firestone W01-358-9270 Hendrickson S-21208 Hendrickson C-20010 Iveco IT9072 Reyco 23433-01 Taurus KR501-01</p>
--------------------------	-------------------	---------------------------------	---

<p><b>GY2B12-440</b></p>	<p>86AR (Trailer)</p>	<p>578-93-3-315 228-1.5</p>	<p>Firestone W01-358-7555 Firestone W01-358-7550 Iveco IT9063 Reyco 20018-01 Reyco 18813-01</p>
--------------------------	-----------------------	---------------------------------	---

## RFS

<p><b>GY1R11-111</b></p>	<p>2000 Series</p>	<p>566-22-3-521 1T15MP7-6297 1T15MP7-7364</p>	<p>Contitech 4157N Firestone W01-358-6297 Firestone 3052 OR 7364 Iveco IT9071 Phoenix 1DK21 A-8 RFS:29-5034A ROR: 2501202 ROR:21221307 Taurus KR915-54</p>
--------------------------	--------------------	---	--

## RIDEWELL

<p><b>GY1R12-352</b></p>	<p>Monopivot 240 U/Slung</p>		<p>Reyco 1003589010C Reyco 12928-01</p>
--------------------------	----------------------------------	--	---

# Section 19 - Air Springs

**PART No.**

**APPLICATION**

**FLEXIBLE MEMBER / ALTERNATE**

## RIDEWELL

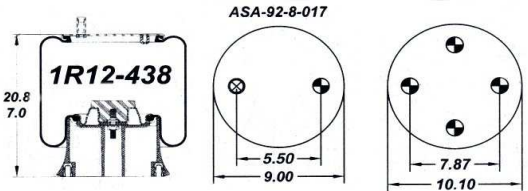
<p><b>GY1R12-438</b></p> 	<p>Ridewell</p>	<p>566-24-3-038</p>	<p>Iveco IT10013 Reyco 1003588805C</p>
--	-----------------	---------------------	--

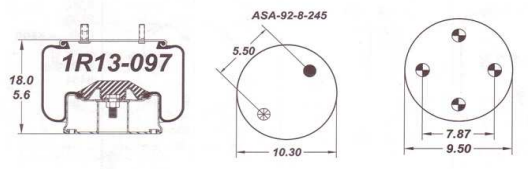
<p><b>GY1R13-097</b></p> 	<p>Monopivot 240</p>	<p>566-26-3-081  1T17B-5</p>	<p>Firestone W01-358-8752 Iveco IT9068 Reyco 1001R13-097 Reyco 1003588752C</p>
---	----------------------	--------------------------------------	--

## R.O.R

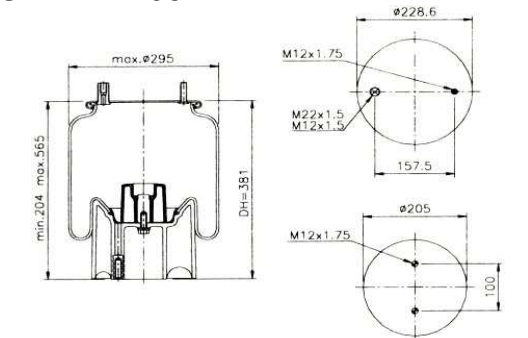
<p><b>GY1R11-106</b></p> 	<p>FL9000 STD 9 Tonne</p>	<p>566-22-3-521  1T15MP-7 M58-7074</p>	<p>Contitech 4157 N P09 Firestone 3053, 7074 Iveco IT10008 S/S TO IT10021 Phoenix 1DK21 A-3 ROR 2122442 Taurus KR913-57</p>
--	-------------------------------	--	---

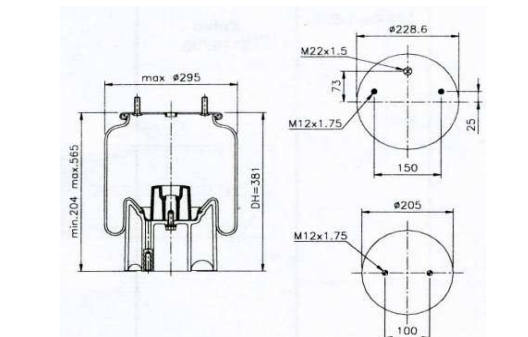
<p><b>GY1R11-111</b></p> 	<p>Flexair, Weweller,</p>	<p>566-22-3-521  1T15MPW7-6297 1T15MPW7-7364</p>	<p>Contitech 4157N P04 Firestone W01-358-6297 Firestone 3052 OR 7364 Iveco IT9071 Krueger 295034-A Phoenix 1DK21 A-8 RFS:29-5034A ROR: 2501202 ROR:21221307 Taurus KR915-54</p>
--	---------------------------	--	---

# Section 19 - Air Springs

**PART No.**

**APPLICATION**

**FLEXIBLE MEMBER / ALTERNATE**

**R.O.R**

<p><b>GY1R14-082</b></p>	<p>ROR</p>	<p>566-28-3-021</p>	<p>Contitech 810MB 2 STUD F/Stone 1T19F-7 M58 7335 Iveco IT10017 ROR 21208327, 17204516</p>
--------------------------	------------	---------------------	---

<p><b>GY1R14-721</b></p>	<p>ROR Flexair FL11000 &amp; FL11000L (Meritor)</p>	<p>566-28-3-503</p>	<p>Firestone 1T19L-11M58 7370 Meritor 2122239</p>
--------------------------	---	---------------------	---

**SAF**

<p><b>GY1R11-709</b></p>	<p>300mm DIA 2618V Trailer, 420mm Ride Height</p>	<p>566-22-3-503</p>	<p>BP1852 Contitech 4022 N P02 F/Stone 1T17BS-6M58 0756 Iveco IT10009 SAF 3.229.0033.00 3229002900, 3228002900 Taurus UR725-28T</p>
--------------------------	---	---------------------	---

<p><b>GY1R14-705</b></p>	<p>SAF 2926V</p>	<p>566-28-3-020  1T19L-11 M58 7345 OR 6364  3228003000</p>	<p>Contitech 813MB 4813N P06 (ALUM) Firestone W01-358-9158 &amp; 6339, 0152 Iveco IT9057 Phoenix 1D28B-2 E2 SAF 2229000300 Taurus K622-26 Volvo 1622116 York 61.505859/01</p>
--------------------------	------------------	--	---

# Section 19 - Air Springs

**PART No.**

**APPLICATION**

**FLEXIBLE MEMBER N ALTERNATE**

## SAF

<p><b>GY1R14-716</b></p>		<p>566-28-3-021  1T19F-7 M58 7337</p>	<p>Contitech 810MB 4 STUDS Firestone W01-358-9177 &amp; 8775, 9179, 7337 Iveco IT9056 Phoenix 1DK-28B, 1D28A2 SAF 2228000200 ROR 2501201, 21215632 Taurus B621, K621-26 York 61.506243/01</p>
--------------------------	--	---	---

<p><b>GY1R14-729</b></p>	<p>SAF 2923V</p>	<p>566-28-3-020</p>	<p>Contitech 4023 N P03 Firestone 1T19L-11 M58 6348 SAF 3228003100 Taurus KR622-18</p>
--------------------------	------------------	---------------------	--

<p><b>GY1R14-730</b></p>	<p>SAF 2918V</p>	<p>566-28-3-021</p>	<p>Firestone 1T19L-7 M58 6338 Phoenix 1D28A-12 SAF 3228002700 Taurus KR621-18</p>
--------------------------	------------------	---------------------	---

## SCANIA

<p><b>GY1R14-727</b></p>	<p>Scania 133, 142/143, M112, M113, M142, R93</p>	<p>566-28-3-020</p>	<p>ATAP BP1838 Contitech 4813 N P07 F/Stone 1T19L-11 M58 7358 Phoenix 1D28B-9 Scania 255295, 298568, 1107674, 1314906, 255293, 325748 Taurus KR622-01</p>
--------------------------	---	---------------------	---

# Section 19 - Air Springs

PART No.

APPLICATION

FLEXIBLE MEMBER N ALTERNATE

## SCANIA

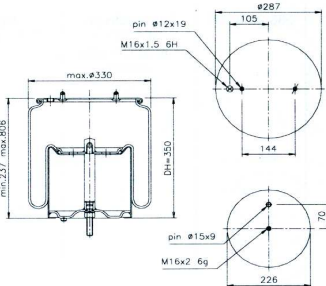
<p><b>GY1R14-753</b></p> 	<p>Scania 94D Series Trucks</p>	<p>556-28-3-522</p>	<p>ATAP BP1853 Contitech 4913N P02 F/Stone 1T19FR-13M58 8098 IT19F-14 095 0366 Phoenix 1D28H-16 Scania 1389392, 1440294</p>
--	-------------------------------------	---------------------	---

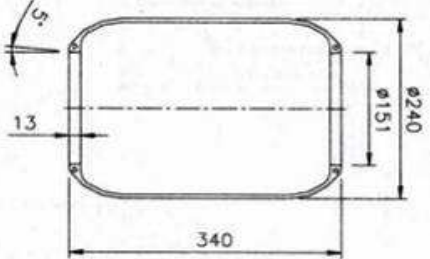
<p><b>GY8015</b></p> 		<p>556-03-8015</p>	<p>Contitech 715N DAF 4763473, 4456111 F/Stone 1R1C 335-310 95-0087 Iveco IT10027 Man 81.43601.0059/60/75... M/Benz 363.328.00.01 Phoenix 1F25 Taurus B144</p>
---	--	--------------------	--

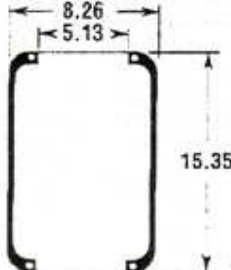
<p><b>GY8017E</b></p> 	<p>S110, S120, S125</p>	<p>556-03-8017E  1R2A-390-295 95-0118</p>	<p>Contitech 644N EVO-02002/2 Iveco IT9059 Man 81.43601.0017 M/Benz 364.327.70.01 Phoenix 1E21 Taurus B121, BL121 Volvo 1134445 York 61.610050</p>
---	-------------------------	---	--

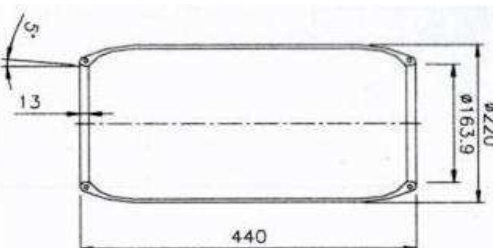
<p><b>GY8028</b></p> 	<p>BR112 BR116 K112 DR K112 OR K112 TR K113 DR, TLA L113 L92/K</p>	<p>556-03-8028</p>	<p>Contitech 897N F/Stone 1R1K 440-320 095 0174, 0229 Iveco IT10024 Scania 0411622, 0411623 Taurus B165</p>
--	--	--------------------	---

# Section 19 - Air Springs

PART No.

APPLICATION

FLEXIBLE MEMBER N ALTERNATE

## SCANIA

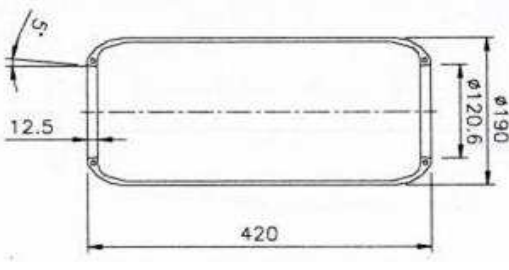
<p><b>GY8037</b></p> 	<p>Bus: K113TLA, K82-112, L113CLD</p>	<p>556-03-8037</p>	<p>Contitech 927N F/Stone 1R1J 415-285 95 0188, 0244 Dennis 611896/12 Iveco IT10031 Leyland AA42542 Phoenix 2E1BE Scania 434932 Taurus B179</p>
--	---	--------------------	---

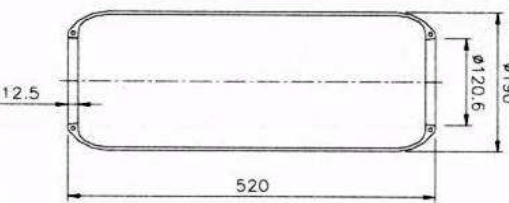
<p><b>GY8040</b></p> 	<p>K112 HDR K112 OR K112 TR K113DR</p>	<p>556-03-8040</p>	<p>Contitech 896N Dennis 0411627 F/Stone 1R1J520-285 095- 0245 Iveco IT10023 Phoenix 2E18-A Scania 411627 Taurus B178</p>
---	--	--------------------	---

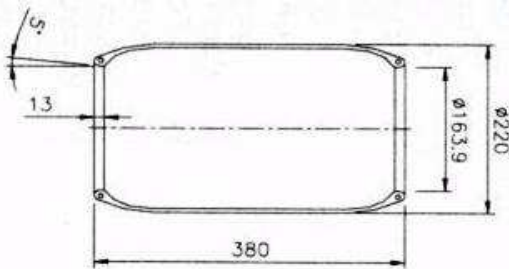
<p><b>GY8042</b></p> 	<p>Bus: K92.K93 VO</p>	<p>556-03-8042</p>	<p>Contitech 928N Iveco 6453741 Iveco IT10032 Phoenix 2E23A Taurus B178</p>
--	------------------------	--------------------	---

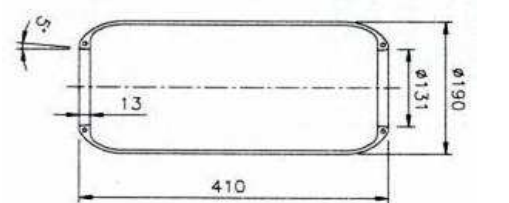
<p><b>GY8043</b></p> 	<p>Scania</p>	<p>556-03-8043</p>	<p>Contitech 921N F/Stone 1R1A 415-260 095 0226 Iveco IT10030 RVI 5 000 288 982</p>
--	---------------	--------------------	---

# Section 19 - Air Springs

PART No.	APPLICATION	FLEXIBLE MEMBER # ALTERNATE
TMC		
<p>GY1R12-602</p> <p style="text-align: center; color: red; font-weight: bold;">IMAGE UNAVAILABLE</p>	Aust. Suspension	BP1857 Iveco IT10015 TMC 626104

## VOLVO

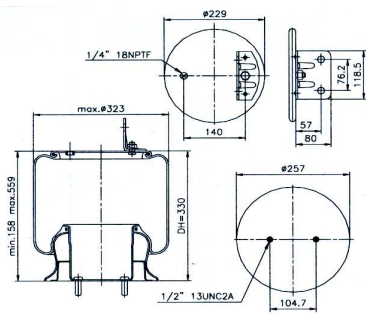
<p>GY1R12-400</p> 		566-24-3-038  ATAP BP1855 Firestone 1T15M- 9296 Volvo 8061151, 8169869
--	--	--

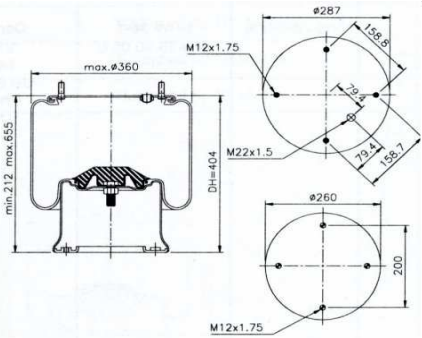
<p>GY1R14-705</p> 		566-28-3-020  1T19L-11 M58 7345 OR 6364  Contitech 813MB 4813N P06 (ALUM) Firestone W01-358-9158 & 6339, 6364, 7345, 0152 Iveco IT9057 Phoenix 1D28B-2 E2 SAF 2229000300 Taurus K622-26 Volvo 1622116 York 61.505859/01
---	--	---

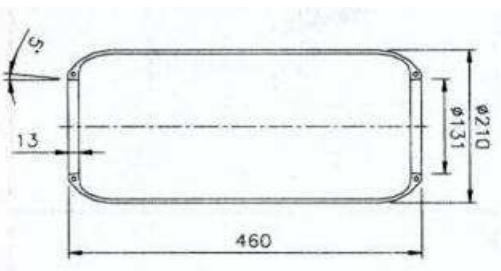
<p>GY8014</p> 		566-03-8014 720N 1R2A-460-290 95- 0063  Volvo: 1629193  Contitech 720N EVO 02001/2 Iveco IT9058 Man 81.43601.0033,36,37 M/Benz A387.328.01.01 Phoenix 1F21 Taurus B152 Taurus B154 (HT134629) York 61.610049
---	--	---

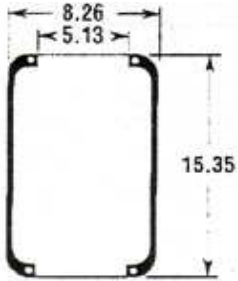
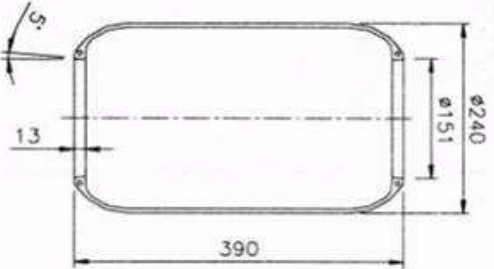
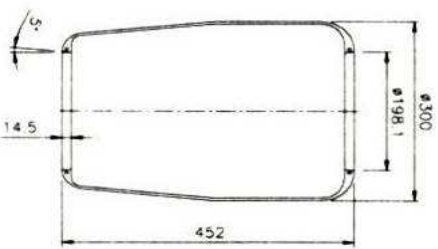

# Section 19 - Air Springs

PART No.	APPLICATION	FLEXIBLE MEMBER N	ALTERNATE
<p>GY8017E</p> 	<p>B10M MK1, MK2, MK4, (Rear) B10B (Rear/ TAG), B10R, B12</p>	<p>556-03-8017E  1R2A-390-295 95- 0118</p>	<p>Contitech 644N EVO-02002/2 Iveco IT9059 Man 81.43601.0017 M/Benz 364.327.70.01 Phoenix 1E21 Taurus B121, BL121 Volvo 1134445 York 61.610050</p>
<p>GY8018</p> 	<p>B10M (F) B10M MK111 (F) C10M (F) F7</p>	<p>556-03-8018</p>	<p>Contitech 661N F/Stone 1R1C 390-310 95- 0021 Iveco 93197594, 4746733 Iveco IT10025 Man 90.83112.0144 Phoenix 1E25 Taurus B114 Volvo 1137882, 1137888</p>
<p>GY8117</p> 	<p>B10R Rear</p>	<p>556-03-8117</p>	<p>Contitech 727N F/Stone 1R2D 460-360 95- 0204 Iveco IT10029 Man 81.43601.0082 M/Benz 307.328.01.01 Phoenix 1F32A Taurus B149 Volvo 1134446</p>
<p>GY1B5-500</p> <p style="text-align: center;"><b>IMAGE UNAVAILABLE</b></p>	<p>B59 Complete Rear</p>		<p>Firestone 1T9G12-7001 Iveco IT10035</p>



# Section 19 - Air Springs

PART No.

APPLICATION

FLEXIBLE MEMBER N ALTERNATE

## VOLVO

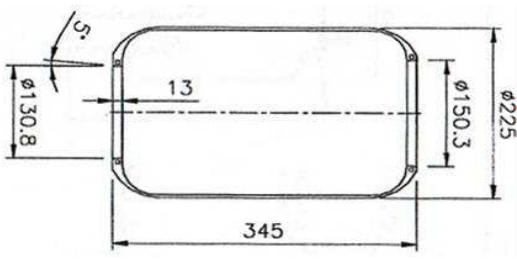
<p><b>GY9004</b></p> 		<p>556-03-9004</p>	<p>Contitech RZ415-25 Phoenix 2G20 Taurus B271 Volvo 3027271</p>
--	--	--------------------	--

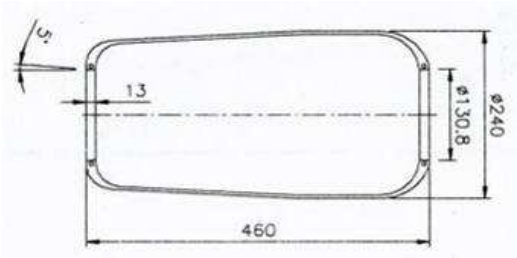
<p><b>GY9008</b></p> 	<p>F10, F12 FL10, FL6 FL611, FL614, FL617 FL7 B55 AILSA Bus B58 Bus</p>	<p>556-03-9008</p>	<p>Contitech 720N F/Stone 1R2A 460-295 95-0195 Iveco IT10028 Man 81.43601.0033/36/37 M/Benz 387.328.0101 M/Benz 387.328.0001 Phoenix 1F21 Taurus B152 Volvo 1590136, 1622115</p>
---	---	--------------------	--

## WESTERN STAR

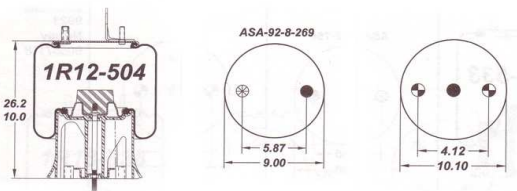
<p><b>GY1R12-504</b></p> 	<p>Neway Suspension</p>	<p>566-24-3-066</p>	<p>Firestone W01-358-9781 Iveco IT9077 Neway 90557146 W/Star 681-320-00-17</p>
--	-------------------------	---------------------	--

## WEWELLER

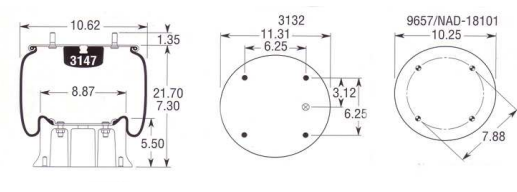
<p><b>GY1R14-716</b></p> 	<p>AC 041/115/134/134L AC 138</p>	<p>566-28-3-021 1T19F-7 OR 1T19L7</p>	<p>Contitech 810MB 4 STUDS Firestone W01-358-9177 &amp; 8775, Firestone W01-358-9179 &amp; 7337 Iveco IT9056 Phoenix 1DK-28B, 1D28A2 ROR 2501201 Taurus B621, K621-26 Weweller US87413F/P</p>
--	---------------------------------------	---	---

# Section 19 - Air Springs

**PART No.**

**APPLICATION**

**FLEXIBLE MEMBER / ALTERNATE**

## YORK

<p><b>GY1R11-039</b></p>	<p>FB 150/300/370mm Ride Height</p>	<p>566-22-3-143</p>	<p>Firestone 9441 Iveco IT9083 York 61.610122</p>
--------------------------	---	---------------------	---

<p><b>GY1R12-092</b></p>	<p>FB (190/400)</p>	<p>566-24-3-038  1T15M-6 OR 1T15K-1</p>	<p>BP1856 Firestone W01-358-9082 Firestone 1TSK1M-6-9082 Hendrickson B-2066, S-2066 Iveco IT9055 Iveco IT9089 Neway 90557006 Phoenix KR602-9082 Reyco 12882-01 York 61.610121</p>
--------------------------	---------------------	---	---

<p><b>GY1R12-355</b></p>	<p>Tecair 2 150mm Ride Height</p>	<p>566-24-3-076  1T15M-2</p>	<p>Firestone W01-358-9078 Iveco IT9067 York 61.787852</p>
--------------------------	---------------------------------------	--------------------------------------	---

<p><b>GY1R14-705</b></p>	<p>Tecair 1 &amp; 2 300/400mm Ride Height</p>	<p>566-28-3-020  1T19L-11 M58 7345 OR 6364</p>	<p>Contitech 813MB 4813N P06 (ALUM) Firestone W01-358-9158 &amp; 6339, 6364, 7345, 0152 Iveco IT9057 Phoenix 1D28B-2 E2 SAF 2229000300 Taurus K622-26 Volvo 1622116 York 61.505859/01</p>
--------------------------	---	--	---

# Section 19 - Air Springs

**PART No.**

**APPLICATION**

**FLEXIBLE MEMBER N ALTERNATE**

## YORK

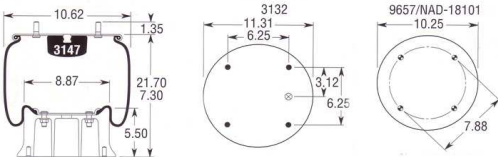
<p><b>GY1R14-716</b></p> 	<p>Tecair 1 &amp; 2 200mm Ride Height</p>	<p>566-28-3-021  1T19F-7 M58 7337</p>	<p>Contitech 810MB 4 STUDS Firestone W01-358-9177 &amp; 8775, Firestone W01-358-9179 &amp; 7337 Iveco IT9056 Phoenix 1DK-28B, 1D28A2 ROR 2501201, 21215632 Taurus B621, KR621-26 York 61.506243/01</p>
--	---	---	--

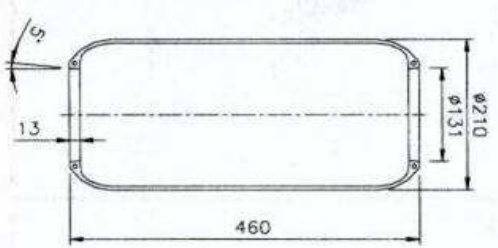
<p><b>GY8014</b></p> 	<p>FB</p>	<p>566-03-8014 720N 1R2A-460-290 95- 0063  Volvo 1629193</p>	<p>Contitech 720N EVO 02001/2 Iveco IT9058 Man 81.43601.0033, 36,37 M/Benz A387.328.01.01 Phoenix 1F21 Taurus B152 Taurus B154 (HT134629) York 61.610049</p>
---	-----------	--	--

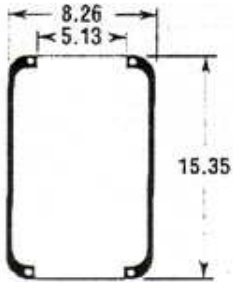
<p><b>GY8017E</b></p> 	<p>FB 150/300/370</p>	<p>556-03-8017E  1R2A-390-295 95- 0118</p>	<p>Contitech 644N EVO-02002/2 Iveco IT9059 Man 81.43601.0017 M/Benz 364.327.70.01 Phoenix 1E21 Taurus B121, BL121 Volvo 1134445 York 61.610050</p>
---	-----------------------	--	--

<p><b>YK61610443</b></p> <p style="text-align: center;"><b>IMAGE UNAVAILABLE</b></p>	<p>FB3 &amp; Duratrac</p>		<p>Firestone 1T19L-7 York 61.610443</p>
--	---------------------------	--	---

# Section 19 - Air Springs

ALTERNATE #	FPA PART #
02001/2	GY8014
02002/2	GY8017E
03.07887	GY1R12-568
0411622	GY8028
0411623	GY8028
0411627	GY8040
0542942200	GY1R11-703
0542942250	GY1R11-700
0542942260	GY1R14-708
0542943600	GY1R14-748
1001R13-097G	GY1R13-097
1003588752C	GY1R13-097
1003588805C	GY1R12-438
1003589010C	GY1R12-352
100358908C	GY1R12-092
1107674	GY1R14-727
1134445	GY8017E
1134446	GY8117
1137882	GY8018
1137888	GY8018
1204516	GY1R14-082
12882-01	GY1R12-092
12883-02	GY1R13-078
12884-01	GY1R12-188
12928-01	GY1R12-421
13147906	GY1R14-727
1379392	GY1R14-753
1389392	GY1R14-753
1440294	GY1R14-753
1590136	GY9008
16-13810-000	GY1R12-303
16-13810-000	GY1R12-603
1622115	GY9008
1622116	GY1R14-705
1660694C1	GY1R12-178
1670043C1	GY1R12-401
1686386C1	GY1R12-401
18813-01	GY2B12-440
1884N1	GY9003
1885N1	GY9003
1D21	GY1R11-700
1D28A2	GY1R14-716
1D28A-12	GY1R14-730
1D28B-2 E2	GY1R14-705
1D28B-9	GY1R14-727
1D28C-26	GY1R14-705
1D28G-26	GY1R14-716
1D28H-16	GY1R14-753
1D32	GY1R14-708
1DK20C-54	GY1R11-111
1DK20D-9422	GY1R11-028
1DK21	GY1R11-700
1DK21A3	GY1R11-106
1DK21A-8	GY1R11-111
1DK23K-9082	GY1R12-092
1DK-28B	GY1R14-716
1DK32	GY1R14-708
1E21	GY8017E
1E25	GY8018
1E32	GY9007
1F20B-1	GY9003
1F20B-2	GY9002

ALTERNATE #	FPA PART #
1F21	GY8014
1F21	GY9008
1F21C-5	GY9015
1F25	GY8015
1F32A	GY8117
1R12-403	HD57122-002
1S12-012	GY1R12-403
1T15L1.5-9422	GY1R11-028
1T15M6-9082	GY1R12-092
1T15M-9333	GY1R12-351
1T15-MP7-6297	GY1R11-111
1T15V8-9471	GY1R12-504
1T17BS-6M580756	GY1R11-709
1T19FR-13M588098	GY1R14-753
1T19G12-7001	GY1B5-500
1T19J6-8050	GY1R14-039
1T19L7-8775	GY1R14-716
1T19L-11M6348	GY1R14-729
1T19L-11M587358	GY1R14-727
1T19L-11M587370	GY1R14-721
1T9G12-7001	GY1B5-500
1TSK1M-6-9082	GY1R12-092
20018-01	GY2B12-440
201559C2	GY1R12-401
21208082	GY1R14-716
21208062	GY1R14-716
21208327	GY1R14-082
21215633	GY1R14-705
21221307	GY1R11-111
21222239	GY1R14-721
21222442	GY1R11-106
2228000200	GY1R14-716
2229000200	GY1R14-716
2229000300	GY1R14-705
227QS33	GY1S4-007
23433-01	GY1R13-119
23521-01	FP23521-01
2501201	GY1R14-716
2501202	GY1R11-111
255293	GY1R14-727
255295	GY1R14-727
295034A	GY1R11-111
298568	GY1R14-727
2E18B	GY8037
2G20	GY9004
3027271	GY9004
3027272	GY9005
3052	GY1R11-111
3053	GY1R11-106
3073280101	GY8117
3228002900	GY1R11-709
3228003000	GY1R14-705
3228002700	GY1R14-730
3228002900	GY1R11-709
3228003100	GY1R14-729
3229002900	GY1R11-709
325748	GY1R14-727
3261050R1	GY1S4-007
363.328.00.01	GY8015
364.327.70.01	GY8017E
387.328.0001	GY9008
387.328.0101	GY9008

ALTERNATE #	FPA PART #
4022NP02	GY1R11-709
4023NP03	GY1R14-729
411627	GY8040
4157NP04	GY1R11-111
4157NP09	GY1R11-106
434932	GY8037
4714025	GY8012
4716989	GY8012
4731030000	GY1R14-705
47311033000	GY1R14-705
4738008	GY8012
4746733	GY8018
4763473	GY8015
4813NP07	GY1R14-727
49048-002	GY1R12-365
4913NP02	GY1R14-753
5022NP02	GY1R11-709
50405	GY1R12-424
506243/01	GY1R14-716
50898-002	GY1R12-402
554762C1	GY1R11-028
556 038 014	GY8014
566-0-3-8017	GY8017E
57QL411M	GY1R12-365
611896/12	GY8037
61.505859/01	GY1R14-705
61.506243/01	GY1R14-716
61.610049	GY8014
61.610050	GY8017E
61.610443	YK61610443
61.610121	GY1R12-092
61.610122	GY1R11-039
61.787852	GY1R12-355
611896/12	GY8037
6144040	GY9001
626104	GY1R12-602
6297	GY1R11-111
6339	GY1R14-705
6364	GY1R14-705
644N	GY8017E
661N	GY8018
662N	GY9007
681-320-0017 (CB)	GY1R12-303
681-320-0017 (SB)	GY1R12-603
6813200017 (SB)	GY1R12-603
7031	GY1S4-007
715N	GY8015
720N	GY8014
720N	GY9008
727N	GY8117
7345	GY1R14-705
7364	GY1R11-111
8050	GY1R14-039
8061151	GY1R12-400
810MB	GY1R14-716
813MB	GY1R14-705
81.43601.0018	GY9007
81.43601.0033	GY8014
81.43601.0036	GY8014
81.43601.0037	GY8014
81.43601.0082	GY8117
81.43601.0095	GY9015

ALTERNATE #	FPA PART #
81.43601.0150	GY9003
8160165	GY9001
8169869	GY1R12-400
8188539	GY9002
8775	GY1R14-716
881MB	GY1R14-708
884N	GY9002
896N	GY8040
897N	GY8028
9039	GY1R12-095
90557006	GY1R12-092
90557009	GY1R12-103
90557020	GY1R13-078
90557023	GY1R12-095
90557071	GY1R13-078
90557076	GY1R13-078
90557077	GY1R13-078
90557086	GY1R12-167
90557112	GY1R12-480
90557113	GY1R12-441
90557117	GY1R12-502
90557118	GY1R12-533
90557146	GY1R12-504
90557147	GY1R12-553
90557152	GY1R12-586
90557155	GY1R14-160
90557156	GY1R12-499
90557161	NE90557161
90557167	GY1R13-152
90557168	GY1R13-153
90557211	GY1R12-554
90557212	GY1R12-552
90557213	GY1R12-553
90557214	GY1R12-485
90557215	GY1R12-484
9082	GY1R12-092
9122	GY1R11-038
9144	GY1R14-160
9130	GY1R12-281
9148	GY1R14-018
916N1	GY9015
921N	GY8043
9270	GY1R13-119
927N	GY8037
9287	GY1R12-365
928N	GY8042
9307	GY1R12-095
93197594	GY8018
9373	GY1R12-403
940MB	GY1R11-703
941MB	GY1R11-700
9422	GY1R11-028
943N	GY9001
944N	GY8012
9441	GY1R11-039
9473	GY1R12-586
9616	GY1R11-078
97134282	GY1R12-351
9780	GY1R12-303
98478799	GY9003
A363.328.00.01	GY8015
A387.328.01.01	GY8014

# Section 19 - Air Springs

ALTERNATE #	FPA PART #	ALTERNATE #	FPA PART #	ALTERNATE #	FPA PART #	ALTERNATE #	FPA PART #
A6583280001	GY9002	FQ7767	GY1R12-188	IT9068	GY1R13-097	S-4771	GY1R14-039
AA42542	GY8037	FQ7769	GY1R13-097	IT9070G	GY1R11-703	T03-AS2501P	GY8017E
AAU2542	GY8037	FQ7770	GY1R12-303	IT9071	GY1R11-111	UCE9393-1	GY1R12-281
AS500-9039	GY1R12-095	FQ7770	GY1R12-603	IT9072	GY1R13-119	UCE9393-2	GY1R12-279
AS506-9082	GY1R12-092	FQ7771	GY1R14-039	IT9073	GY1R12-303	UCE9393-3	GY1R12-281
B-14487	GY3B12-312	FQ7772	GY1R11-106	IT9074	GY1R12-281	UCE9393-4	GY1R12-281
B114	GY9007	FQ7773	GY1R11-221	IT9075	GY1R12-484	UR725-28T	GY1R11-709
B114	GY8018	FQ7774	GY1R11-222	IT9076	GY1R12-502	UR730-01	GY1R11-700
B121	GY8017E	FQ7776	GY1R12-401	IT9077	GY1R12-504	UR732-01	GY1R11-703
B144	GY8015	HD57122-002	GY1R12-403	IT9078	GY1R12-481	UR836-01	GY1R14-708
B149	GY8117	HDB-2066	GY1R12-509	IT9079	GY1R11-221	US87413F/P	GY1R14-716
B152E	GY8014	HDC-20127	GY1R13-118	IT9080	GY1R11-222	W01-358-0152	GY1R14-705
B152E	GY8014	IT10001	GY2B9-201	IT9081	GY1R14-160	W01-358-6297	GY1R11-111
B152E	GY9008	IT10002	GY8012	IT9082	GY1R14-018	W01-358-7337	GY1R14-716
B154	GY8014	IT10003	GY9002	IT9083	GY1R11-039	W01-358-7550	GY2B12-440
B154	GY9015	IT10004	GY9001	IT9084	GY1R12-568	W01-358-7555	GY2B12-440
B165	GY8028	IT10005	GY1R12-552	IT9085	GY1R12-552	W01-358-8050	GY1R14-039
B179	GY8037	IT10006	GY1R12-403	IT9086	GY1R12-402	W01-358-8091	GY1R14-171
B194	GY9001	IT10007	GY1R12-069	IT9087	GY2B10-226	W01-358-8752	GY1R13-097
B-2063	GY1R14-030	IT10008	GY1R11-106	IT9088	GY3B12-312	W01-358-8775	GY1R14-716
B-2065	GY1R14-028	IT10009	GY1R11-709	IT9089	GY1R12-092	W01-358-8855	GY1R12-167
B-2066 AL BASE	GY1R12-092	IT10010	GY1R12-167	IT9090	GY1R13-038	W01-358-8944	GY1R12-366
B-2066 AL BASE	GY1R12-509	IT10011	GY1R12-279	IT9091	GY1R14-039	W01-358-9010	GY1R12-421
B-2630	GY2B9-201	IT10012	GY1R12-424	IT9092	GY1R12-365	W01-358-9015	GY1R12-366
B271	GY9004	IT10013	GY1R12-438	IT9093	GY2B12-324	W01-358-9078	GY1R12-355
B-3830	GY1R13-038	IT10014	GY1R12-554	IT9094	GY1R12-375	W01-358-9082	GY1R12-092
B-3842	GY1R12-103	IT10015	GY1R12-602	IT9095	GY1R13-118	W01-358-9101	GY1R12-103
B-4771	GY1R14-039	IT10016	GY1R13-152	IT9096	GY1R12-366	W01-358-9144	GY1R14-160
B621	GY1R14-716	IT10017	GY1R14-082	IT9097	GY1R13-159	W01-358-9148	GY1R14-018
BL121E	GY8017E	IT10019	GY1R12-095	IT9098	GY1R14-171	W01-358-9158	GY1R14-705
BL249	GY9002	IT10020	GY1R12-553	IT9099	GY1R12-256	W01-358-9177	GY1R14-716
C-13122	GY1R14-127	IT10021	GY1R11-106	K303-6	GY1R11-028	W01-358-9179	GY1R14-716
C-14249	GY1R12-256	IT10023	GY8040	K303-14	GY1R11-028	W01-358-9213	GY1R12-401
C-20010	GY1R13-119	IT10024	GY8028	K303-15	GY1R11-028	W01-358-9223	GY1R12-188
C-20124	GY1R12-375	IT10025	GY8018	K303-16	FP9066	W01-358-9265	GY1R12-375
C-20127	GY1R13-118	IT10026	GY9007	K303-18	GY1R11-219	W01-358-9270	GY1R13-119
C-20217	GY1R12-366	IT10027	GY8015	K303-19	GY1R11-220	W01-358-9371	GY1R12-401
C-20900	GY1R13-159	IT10028	GY9008	K303-22	GY1R11-221	W01-358-9373	GY1R12-403
C-20901	GY1R14-171	IT10029	GY8117	K303-25	GY1R11-222	W01-358-9379	GY1R12-178
C-21208	GY1R13-119	IT10030	GY8043	K303-6	GY1R11-028	W01-358-9422	GY1R11-028
C-21784	GY1R14-171	IT10031	GY8037	K374-9	GY1R11-018	W01-358-9466	GY1R12-365
C-22173	GY1R13-078	IT10032	GY8042	K621-26	GY1R14-716	W01-358-9472	GY1R12-553
C-23612	HDS-21612	IT10033	GY9003	K621-9149	GY1R14-018	W01-358-9483	NE90557161
CF1524873-04	GY1R12-279	IT10034	GY9005	K622-33SU	GY1R13-118	W01-358-9504	GY1R12-485
EVO-02001/2	GY8014	IT10035	GY1B5-500	KR501-01	GY1R13-119	W01-358-9616	FP9066
EVO-02002/2	GY8017E	IT10045	GY1R11-219	KR504-04	GY1R12-365	W01-358-9617	GY1R11-219
FP9073S	GY1R12-603	IT10046	GY1R11-220	KR602-9082	GY1R12-092	W01-358-9618	GY1R11-220
FQ7750CG	GY1R14-748	IT10047	TBA	KR621-18	GY1R14-730	W01-358-9622	GY1R11-221
FQ7750G	GY1R14-708	IT9050	GY1R11-028	KR621-26	GY1R14-716	W01-358-9625	GY1R11-222
FQ7751G	GY1R11-700	IT9051	GY1R14-039	KR622-01	GY1R14-727	W01-358-9645	HDS-23612
FQ7753G	GY1R11-703	IT9053	GY1R8-009	KR622-18	GY1R14-729	W01-358-9780	GY1R12-303
FQ7755	GY1R12-092	IT9054	GY1S4-007	KR622-26	GY1R14-705	W01-358-9781	GY1R12-504
FQ7756	GY1R12-504	IT9055	GY1R12-092	KR913-57	GY1R11-106	W01-544-9614	GY1R11-028
FQ7757	GY1R11-028	IT9056	GY1R14-716	KR915-54	GY1R11-111	W01-755-8740	GY1R13-119
FQ7758	GY8014	IT9057	GY1R14-705	R732	GY1R11-703	W01-755-8855	GY1R12-167
FQ7759	GY8017E	IT9058	GY8014	RZ 415-28	GY9005	ZPD1R11-018	GY1R11-018
FQ7760	GY1R12-167	IT9059	GY8017E	RZ415-25	GY9004	ZPDBPW30	GY1R11-700
FQ7761	GY1R12-502	IT9060G	GY1R11-700	S-14318	GY2B12-324	ZPDBPW30K	GY1R11-703
FQ7762	GY1R11-111	IT9061G	GY1R14-708	S-2066	GY1R12-092	ZPDBPW36	GY1R14-708
FQ7763	GY1R14-716	IT9063	GY2B12-440	S-21208	GY1R13-119	W01-358-8748	GY1R13-152
FQ7764	GY1R12-279	IT9064	GY1R12-188	S-21800	GY1R13-159		
FQ7765	GY2B12-440	IT9066	FP9066	S-23612	HDS-23612		
FQ7766	GY1R12-481	IT9067	GY1R12-355	S-3053-C	GY1R13-038		

# Section 19 - Air Springs

FPA PART #	ALTERNATE #	FPA PART #	ALTERNATE #	FPA PART #	ALTERNATE #	FPA PART #	ALTERNATE #
FP23521-01	23521-01	GY1R11-700	0542942250	GY1R12-279	FQ7764	GY1R12-499	90557156
FP9066	IT9066	GY1R11-700	1D21	GY1R12-279	IT10011	GY1R12-502	90557117
FP9066	K303-16	GY1R11-700	1DK21	GY1R12-279	UCE9393-2	GY1R12-502	FQ7761
FP9066	W01-358-9616	GY1R11-700	941MB	GY1R12-281	9130	GY1R12-502	IT9076
GY1B5-500	1T19G12-7001	GY1R11-700	FQ7751G	GY1R12-281	IT9074	GY1R12-504	1T15V8-9471
GY1B5-500	1T9G12-7001	GY1R11-700	IT9060G	GY1R12-281	UCE9393-1	GY1R12-504	90557146
GY1B5-500	IT10035	GY1R11-700	UR730-01	GY1R12-281	UCE9393-3	GY1R12-504	FQ7756
GY1R11-018	K374-9	GY1R11-700	ZPDBPW30	GY1R12-281	UCE9393-4	GY1R12-504	IT9077
GY1R11-018	ZPD1R11-018	GY1R11-703	0542942200	GY1R12-303	16-13810-000	GY1R12-504	W01-358-9781
GY1R11-028	1DK20D-9422	GY1R11-703	940MB	GY1R12-303	681-320-0017 (CB)	GY1R12-509	B-2066 AL BASE
GY1R11-028	1T15L1.5-9422	GY1R11-703	FQ7753G	GY1R12-303	9780	GY1R12-509	HDB-2066
GY1R11-028	554762C1	GY1R11-703	IT9070G	GY1R12-303	FQ7770	GY1R12-533	90557118
GY1R11-028	9422	GY1R11-703	R732	GY1R12-303	IT9073	GY1R12-552	90557212
GY1R11-028	FQ7757	GY1R11-703	UR732-01	GY1R12-303	W01-358-9780	GY1R12-552	IT10005
GY1R11-028	IT9050	GY1R11-703	ZPDBPW30K	GY1R12-351	1T15M-9333	GY1R12-552	IT9085
GY1R11-028	K303-6	GY1R11-709	1T17BS-6M580756	GY1R12-351	97134282	GY1R12-553	90557213
GY1R11-028	K303-14	GY1R11-709	3228002900	GY1R12-352	1003589010C	GY1R12-553	IT10020
GY1R11-028	K303-15	GY1R11-709	3228002900	GY1R12-355	61.787852	GY1R12-553	W01-358-9472
GY1R11-028	K303-6	GY1R11-709	3229002900	GY1R12-355	IT9067	GY1R12-554	90557211
GY1R11-028	W01-358-9422	GY1R11-709	4022NP02	GY1R12-355	W01-358-9078	GY1R12-554	IT10014
GY1R11-028	W01-544-9614	GY1R11-709	5022NP02	GY1R12-365	49048-002	GY1R12-568	03.07887
GY1R11-038	9122	GY1R11-709	IT10009	GY1R12-365	57QL411M	GY1R12-568	IT9084
GY1R11-039	61.610122	GY1R11-709	UR725-28T	GY1R12-365	9287	GY1R12-586	90557152
GY1R11-039	9441	GY1R12-069	IT10007	GY1R12-365	IT9092	GY1R12-586	9473
GY1R11-039	IT9083	GY1R12-092	100358908C	GY1R12-365	KR504-04	GY1R12-602	626104
GY1R11-078	9616	GY1R12-092	12882-01	GY1R12-365	W01-358-9466	GY1R12-602	IT10015
GY1R11-106	1DK21A3	GY1R12-092	1DK23K-9082	GY1R12-366	C-20217	GY1R12-603	16-13810-000
GY1R11-106	21222442	GY1R12-092	1T15M6-9082	GY1R12-366	IT9096	GY1R12-603	681-320-0017 (SB)
GY1R11-106	3053	GY1R12-092	1TSK1M-6-9082	GY1R12-366	W01-358-8944	GY1R12-603	6813200017 (SB)
GY1R11-106	4157NP09	GY1R12-092	61.610121	GY1R12-366	W01-358-9015	GY1R12-603	FP9073S
GY1R11-106	FQ7772	GY1R12-092	90557006	GY1R12-375	C-20124	GY1R12-603	FQ7770
GY1R11-106	IT10008	GY1R12-092	9082	GY1R12-375	IT9094	GY1R13-038	B-3830
GY1R11-106	IT10021	GY1R12-092	AS506-9082	GY1R12-375	W01-358-9265	GY1R13-038	IT9090
GY1R11-106	KR913-57	GY1R12-092	B-2066 AL BASE	GY1R12-400	8061151	GY1R13-038	S-3053-C
GY1R11-111	1DK20C-54	GY1R12-092	FQ7755	GY1R12-400	8169869	GY1R13-078	12883-02
GY1R11-111	1DK21A-8	GY1R12-092	IT9055	GY1R12-401	1670043C1	GY1R13-078	90557020
GY1R11-111	1T15-MP7-6297	GY1R12-092	IT9089	GY1R12-401	1686386C1	GY1R13-078	90557071
GY1R11-111	21221307	GY1R12-092	KR602-9082	GY1R12-401	201559C2	GY1R13-078	90557076
GY1R11-111	2501202	GY1R12-092	S-2066	GY1R12-401	FQ7776	GY1R13-078	90557077
GY1R11-111	295034A	GY1R12-092	W01-358-9082	GY1R12-401	W01-358-9213	GY1R13-078	C-22173
GY1R11-111	3052	GY1R12-095	9039	GY1R12-401	W01-358-9371	GY1R13-097	1001R13-097G
GY1R11-111	4157NP04	GY1R12-095	90557023	GY1R12-402	50898-002	GY1R13-097	1003588752C
GY1R11-111	6297	GY1R12-095	9307	GY1R12-402	IT9086	GY1R13-097	FQ7769
GY1R11-111	7364	GY1R12-095	AS500-9039	GY1R12-403	1S12-012	GY1R13-097	IT9068
GY1R11-111	FQ7762	GY1R12-095	IT10019	GY1R12-403	9373	GY1R13-097	W01-358-8752
GY1R11-111	IT9071	GY1R12-103	90557009	GY1R12-403	HD57122-002	GY1R13-118	C-20127
GY1R11-111	KR915-54	GY1R12-103	B-3842	GY1R12-403	IT10006	GY1R13-118	HDC-20127
GY1R11-111	W01-358-6297	GY1R12-103	W01-358-9101	GY1R12-403	W01-358-9373	GY1R13-118	IT9095
GY1R11-219	IT10045	GY1R12-167	90557086	GY1R12-421	12928-01	GY1R13-118	K622-33SU
GY1R11-219	K303-18	GY1R12-167	FQ7760	GY1R12-421	W01-358-9010	GY1R13-119	23433-01
GY1R11-219	W01-358-9617	GY1R12-167	IT10010	GY1R12-424	50405	GY1R13-119	9270
GY1R11-220	IT10046	GY1R12-167	W01-358-8855	GY1R12-424	IT10012	GY1R13-119	C-20010
GY1R11-220	K303-19	GY1R12-167	W01-755-8855	GY1R12-438	1003588805C	GY1R13-119	C-21208
GY1R11-220	W01-358-9618	GY1R12-178	1660694C1	GY1R12-438	IT10013	GY1R13-119	IT9072
GY1R11-221	FQ7773	GY1R12-178	W01-358-9379	GY1R12-441	90557113	GY1R13-119	KR501-01
GY1R11-221	IT9079	GY1R12-188	12884-01	GY1R12-480	90557112	GY1R13-119	S-21208
GY1R11-221	K303-22	GY1R12-188	FQ7767	GY1R12-481	FQ7766	GY1R13-119	W01-358-9270
GY1R11-221	W01-358-9622	GY1R12-188	IT9064	GY1R12-481	IT9078	GY1R13-119	W01-755-8740
GY1R11-222	FQ7774	GY1R12-188	W01-358-9223	GY1R12-484	90557215	GY1R13-152	90557167
GY1R11-222	IT9080	GY1R12-256	C-14249	GY1R12-484	IT9075	GY1R13-152	IT10016
GY1R11-222	K303-25	GY1R12-256	IT9099	GY1R12-485	90557214	GY1R13-153	90557168
GY1R11-222	W01-358-9625	GY1R12-279	CF1524873-04	GY1R12-485	W01-358-9504	GY1R13-159	C-20900

# Section 19 - Air Springs

FPA PART #	ALTERNATE #	FPA PART #	ALTERNATE #	FPA PART #	ALTERNATE #	FPA PART #	ALTERNATE #
GY1R13-159	IT9097	GY1R14-716	810MB	GY8014	556 038 014	GY8117	1F32A
GY1R13-159	S-21800	GY1R14-716	8775	GY8014	61.610049	GY8117	3073280101
GY1R14-018	9148	GY1R14-716	B621	GY8014	720N	GY8117	727N
GY1R14-018	IT9082	GY1R14-716	FQ7763	GY8014	81.43601.0033	GY8117	81.43601.0082
GY1R14-018	K621-9149	GY1R14-716	IT9056	GY8014	81.43601.0036	GY8117	B149
GY1R14-018	W01-358-9148	GY1R14-716	K621-26	GY8014	81.43601.0037	GY8117	IT10029
GY1R14-028	B-2065	GY1R14-716	KR621-26	GY8014	A387.328.01.01	GY9001	6144040
GY1R14-030	B-2063	GY1R14-716	US87413F/P	GY8014	B152E	GY9001	8160165
GY1R14-039	1T19J6-8050	GY1R14-716	W01-358-7337	GY8014	B152E	GY9001	943N
GY1R14-039	8050	GY1R14-716	W01-358-8775	GY8014	B154	GY9001	B194
GY1R14-039	B-4771	GY1R14-716	W01-358-9177	GY8014	EVO-02001/2	GY9001	IT10004
GY1R14-039	FQ7771	GY1R14-716	W01-358-9179	GY8014	FQ7758	GY9002	1F20B-2
GY1R14-039	IT9051	GY1R14-721	1T19L-11M587370	GY8014	IT9058	GY9002	8188539
GY1R14-039	IT9091	GY1R14-721	21222239	GY8015	1F25	GY9002	884N
GY1R14-039	S-4771	GY1R14-727	1107674	GY8015	363.328.00.01	GY9002	A6583280001
GY1R14-039	W01-358-8050	GY1R14-727	13147906	GY8015	4763473	GY9002	BL249
GY1R14-082	1204516	GY1R14-727	1D28B-9	GY8015	715N	GY9002	IT10003
GY1R14-082	21208327	GY1R14-727	1T19L-11M587358	GY8015	A363.328.00.01	GY9003	1884N1
GY1R14-082	IT10017	GY1R14-727	255293	GY8015	B144	GY9003	1885N1
GY1R14-127	C-13122	GY1R14-727	255295	GY8015	IT10027	GY9003	1F20B-1
GY1R14-160	90557155	GY1R14-727	298568	GY8017E	02002/2	GY9003	81.43601.0150
GY1R14-160	9144	GY1R14-727	325748	GY8017E	1134445	GY9003	98478799
GY1R14-160	IT9081	GY1R14-727	4813NP07	GY8017E	1E21	GY9003	IT10033
GY1R14-160	W01-358-9144	GY1R14-727	KR622-01	GY8017E	364.327.70.01	GY9004	2G20
GY1R14-171	C-20901	GY1R14-729	1T19L-11M6348	GY8017E	566-0-3-8017	GY9004	3027271
GY1R14-171	C-21784	GY1R14-729	3228003100	GY8017E	61.610050	GY9004	B271
GY1R14-171	IT9098	GY1R14-729	4023NP03	GY8017E	644N	GY9004	RZ415-25
GY1R14-171	W01-358-8091	GY1R14-729	KR622-18	GY8017E	B121	GY9005	3027272
GY1R14-705	1622116	GY1R14-730	1D28A-12	GY8017E	BL121E	GY9005	IT10034
GY1R14-705	1D28B-2 E2	GY1R14-730	3228002700	GY8017E	EVO-02002/2	GY9005	RZ 415-28
GY1R14-705	1D28C-26	GY1R14-730	KR621-18	GY8017E	FQ7759	GY9007	1E32
GY1R14-705	21215633	GY1R14-748	0542943600	GY8017E	IT9059	GY9007	662N
GY1R14-705	2229000300	GY1R14-748	FQ7750CG	GY8017E	T03-AS2501P	GY9007	81.43601.0018
GY1R14-705	3228003000	GY1R14-753	1379392	GY8018	1137882	GY9007	B114
GY1R14-705	4731030000	GY1R14-753	1389392	GY8018	1137888	GY9007	IT10026
GY1R14-705	47311033000	GY1R14-753	1440294	GY8018	1E25	GY9008	1590136
GY1R14-705	61.505859/01	GY1R14-753	1D28H-16	GY8018	4746733	GY9008	1622115
GY1R14-705	6339	GY1R14-753	1T19FR-13M588098	GY8018	661N	GY9008	1F21
GY1R14-705	6364	GY1R14-753	4913NP02	GY8018	93197594	GY9008	387.328.0001
GY1R14-705	7345	GY1R8-009	IT9053	GY8018	B114	GY9008	387.328.0101
GY1R14-705	813MB	GY1S4-007	227QS33	GY8018	IT10025	GY9008	720N
GY1R14-705	IT9057	GY1S4-007	3261050R1	GY8028	0411622	GY9008	B152E
GY1R14-705	KR622-26	GY1S4-007	7031	GY8028	0411623	GY9008	IT10028
GY1R14-705	W01-358-0152	GY1S4-007	IT9054	GY8028	897N	GY9015	1F21C-5
GY1R14-705	W01-358-9158	GY2B10-226	IT9087	GY8028	B165	GY9015	81.43601.0095
GY1R14-708	0542942260	GY2B12-324	IT9093	GY8028	IT10024	GY9015	916N1
GY1R14-708	1D32	GY2B12-324	S-14318	GY8037	2E18B	GY9015	B154
GY1R14-708	1DK32	GY2B12-440	18813-01	GY8037	434932	HD57122-002	1R12-403
GY1R14-708	881MB	GY2B12-440	20018-01	GY8037	611896/12	HDS-21612	C-23612
GY1R14-708	FQ7750G	GY2B12-440	FQ7765	GY8037	611896/12	HDS-23612	S-23612
GY1R14-708	IT9061G	GY2B12-440	IT9063	GY8037	927N	HDS-23612	W01-358-9645
GY1R14-708	UR836-01	GY2B12-440	W01-358-7550	GY8037	AA42542	NE90557161	90557161
GY1R14-708	ZPDBPW36	GY2B12-440	W01-358-7555	GY8037	AAU2542	NE90557161	W01-358-9483
GY1R14-716	1D28A2	GY2B9-201	B-2630	GY8037	B179	TBA	IT10047
GY1R14-716	1D28G-26	GY2B9-201	IT10001	GY8037	IT10031	YK61610443	61.610443
GY1R14-716	1DK-28B	GY3B12-312	B-14487	GY8040	0411627	GY1R13-152	W01-358-8748
GY1R14-716	1T19L7-8775	GY3B12-312	IT9088	GY8040	411627		
GY1R14-716	21208082	GY8012	4714025	GY8040	896N		
GY1R14-716	21208062	GY8012	4716989	GY8040	IT10023		
GY1R14-716	2228000200	GY8012	4738008	GY8042	928N		
GY1R14-716	2229000200	GY8012	944N	GY8042	IT10032		
GY1R14-716	2501201	GY8012	IT10002	GY8043	921N		
GY1R14-716	506243/01	GY8014	02001/2	GY8043	IT10030		
GY1R14-716	61.506243/01	GY8014	1F21	GY8117	1134446		